

ORDINANCE NO. 17-3894

AN ORDINANCE OF THE CITY OF KELSO AMENDING ORDINANCE NO. 11-3741, UPDATING CHAPTERS 1, 2, 3 AND 4 OF THE KELSO ENGINEERING DESIGN MANUAL

WHEREAS the City of Kelso's Western Washington Phase II Municipal Stormwater Permit (Permit) requires that the City adopt and be effective by June 30, 2017 an ordinance to regulate runoff from construction, development and redevelopment to include Low Impact Development; and

WHEREAS the Kelso Engineering Design Manual was rewritten to include these new state mandated requirements and to provide technical standards for their implementation; and

WHEREAS it is proposed that the Kelso Engineering Design Manual be revised by replacing Chapters 1, 2, 3 and 4 as shown in the attached "Exhibit A", to be in compliance with the Permit; now therefore,

THE CITY COUNCIL OF THE CITY OF KELSO DO ORDAIN AS FOLLOWS:

SECTION 1: That the City of Kelso hereby amends the Kelso Engineering Design Manual by updating Chapters 1, 2, 3 and 4 as set forth in Exhibit A, attached hereto and incorporated fully by this reference.

SECTION 2: This Ordinance shall be in full force and effect five (5) days after its passage and publication of summary as required by law.

ADOPTED by the City Council and **SIGNED** by the Mayor this 20th day June, 2017.



Mayor

ATTEST/AUTHENTICATION:



CITY CLERK

APPROVED AS TO FORM:

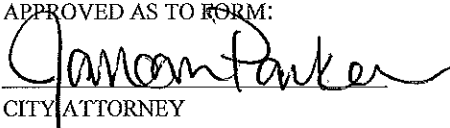

CITY ATTORNEY

PUBLISHED: June 24, 2017

City of Kelso Engineering Design Manual

Adopted by
City of Kelso City Council
February 1, 2011
Amended June 20, 2017



Effective
February 6, 2011
Amended Effective Date June 25, 2017

Contents

Chapter 1:	General Design Requirements
Chapter 2:	Storm Drainage, Grading, and Erosion Control
Appendix 2-A:	Storm Drainage Standard Details
Appendix 2-B:	Design Storm Data
Appendix 2-C:	Example Stormwater Improvement Restrictive Covenant
Chapter 3:	Streets
Chapter 4:	Vacant
Chapter 5:	Water
Chapter 6:	Wastewater

City of Kelso ENGINEERING DESIGN MANUAL

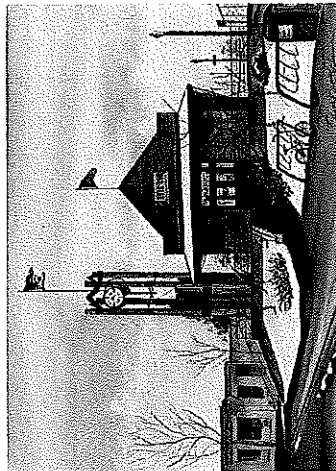

Adopted by City of Kelso City Council
February 1, 2011
Amended June 20, 2017

Effective
February 6, 2011
Amended Effective Date June 25, 2017

Chapter 1
 General Design Requirements
 City of Kelso
 Engineering Design Manual
 February 2011
 Amended June 2017

Chapter 1
 General Design Requirements

Table of Contents

Description	Page No.
1.00 Requirements for Public Improvements	1
1.01 Precedence of Documents	1
1.02 Abbreviations and Definitions	2
1.03 Permits	8
1.04 Submittal Requirements	8
A. General	8
B. Design Plan Format Specifications	8
C. Civil Site Development Plan Submittal	10
D. Site Grading Plan Submittal	13
E. Structural Submittal	13
F. Other Requirements	13
G. Stormwater Submittals Guide	14
H. Specifications for Site Development Drawings	15
I. Specifications for Drainage Design Report	18
J. Specifications for Long-Term Stormwater Site Management Plan	30
K. Specifications for Construction Stormwater Pollution Prevention Plan	31
L. Transportation Impact Study	32
M. Street Access Connection Permit	42
N. Project Acceptance and Closeout	43
1.05 Professional Qualifications	43
1.06 Changes to these Engineering Standards	44
1.07 Design Modification Process	44
1.08 Errors and Omissions	45
1.09 Inspection	45
1.10 Contractor's Responsibility for Scheduling	47
1.11 Contractor's Responsibility for Testing	48

1.12	Safety Requirements	49
1.13	Preservation, Restoration, and Cleanup	49
1.14	Railroad Crossings	51
1.15	Penalties	51

CHAPTER 1 – GENERAL DESIGN REQUIREMENTS

1.00 Requirements for Public Improvements

A. General

The purpose of this document is to set standards for the design and construction of public improvements. These include street, bikeway, drainage, water, and sanitary sewer improvements as required by the development review process, City ordinance, and other City policies adopted by the City. Standards for site grading, drainage, erosion control, parking lot, private street, and driveway construction on private property are also contained in the KEDM. No such work shall commence prior to City approval of the construction plans. Design submitted shall be stamped by a registered professional engineer licensed to practice in the State of Washington, or as otherwise approved by the Director.

All public improvements and private streets, parking lots, sidewalks, and driveways shall be designed and constructed in such a manner as to be readily accessible to and usable by individuals with disabilities as per the requirements of the Americans with Disabilities Act of 1990. This includes providing curb ramps at intersections with pedestrian crosswalks to allow a smooth transition between street and sidewalk elevations.

B. Shortened Designation

This City of Keiseo Engineering Design Manual shall be cited routinely in the text as the "KEDM."

C. Applicability

The KEDM shall govern all new construction and upgrading of facilities both in the right-of-way and on-site for: transportation-related facilities; storm drainage facilities and stream channel improvements; sewer and water improvements; and park, recreation, and open-space facilities used by the public.

1.01 Precedence of Documents

If there is a conflict between approved documents, the document highest in precedence shall control. The precedence shall be:

- First: Permits from other agencies as may be required by law.
- Second: Modifications to the KEDM as approved by the Director.

- Third: Conditions of approval, facilities review, and site development permit.
 - Fourth: City of Kelso Ordinances.
 - Fifth: KEDM.
 - Sixth: The 2012 Stormwater Management Manual for Western Washington, as amended in December 2014 (where applicable).
 - Seventh: Plans and details prepared by the Design Engineer.
 - Eighth: WSDOT Standards Specifications for Road, Bridges, and Municipal Construction.
 - Ninth: Reference specifications.
- Supplemental written agreements and approved revisions to plans and specifications by the appropriate jurisdiction will take precedence over documents listed above. Detailed plans shall have precedence over general plans. In any event, the determination of the Director shall be final.

1.02 Abbreviations and Definitions

AASHTO	American Association of State Highway and Transportation Officials.
ADA	Americans with Disabilities Act of 1990.
Applicant	Any person, firm or corporation applying for public services, or responsible party for a development application.
ASTM	American Society for Testing and Materials.
Best Management Practice (BMP)	The schedules of activities, prohibitions of practices, maintenance procedures, and structural and/or managerial practices that when used singly or in combination, prevent or reduce the release of pollutants and other adverse impacts to waters of Washington State or the stormwater drainage system.
Bicycle Facilities	A general term denoting improvements and provisions which accommodate or encourage bicycling, including parking facilities, maps, signs, pathways, bike lanes, widened sidewalks, bikeways, and shared roadways designated for bicycle use.
Bicycle Lane (Blue Lane)	A portion of a roadway, which has been designated by striping, signing and pavement markings for the preferential or exclusive use of bicyclists.
BMP	Best Management Practice

Biorotation BMP	Engineered facilities that store and treat stormwater by passing it through a specified soil profile, and either retain or detain the treated stormwater for flow attenuation.
City	City of Kelso.
City Engineer	City Engineer for the City of Kelso or their Designee.
Connection	As used in relation to transportation systems, the connection of a private or public street, driveway, or alley at the right-of-way line to a public street. As used in relation to a storm drainage system, the connection of a private storm drainage system to the municipal stormwater drainage system.
Construction Stormwater Pollution Prevention Plan (CSWPPP)	A document that describes the potential for pollution problems on a construction project and explains and illustrates the measures to be taken on the construction site to control those problems.
Continuous simulation hydrologic model	A computer model used to simulate the physical processes of surface water runoff over an extended period of time using continuous meteorological and streamflow records. Models approved for use in designing flow control facilities (MP7) and on-site stormwater management BMPs on sites meeting the LID Performance Standard are listed in the SWMMNW, Vol. II, Section 2.1.
Contractor	The agent of the applicant completing the construction activities associated with a given project.
Developer	The owner and/or their agents or contractors responsible for a given project.
Development	Any improvement, public or private, which requires a building or civil engineering permit.
Director	Community Development Director/City Engineer or their designee.
Dispersion	Release of surface and stormwater runoff such that the flow spreads over a wide area and is located so as not to allow flow to concentrate anywhere upstream of a drainage channel with erodible underlying granular soils.
DOH	Washington State Department of Health.
Driveway	Any access to any property that is not defined under a public or private road.
Ecology	Washington State Department of Ecology

Erosion	The wearing away of the land surface by running water, wind, ice, or other geological agents, including such processes as gravitational creep. Also, detachment and movement of soil or rock fragments by water, wind, ice, or gravity.
Applicant Engineer	A Professional Engineer doing the project design.
fps	Feet per second
Hard Surface	An impervious surface, a permeable pavement, or a vegetated roof.
HMA	Hot Mix Asphalt. Also known as asphaltic concrete.
Impervious surface	A non-vegetated surface area that either prevents or retards the entry of water into the soil mantle as under natural conditions prior to development. A non-vegetated surface area which causes water to run off the surface in greater quantities or at an increased rate of flow from the flow present under natural conditions prior to development. Common impervious surfaces include but are not limited to roof tops, walkways, patios, driveways, parking lots or storage areas, concrete or asphalt paving, gravel roads, packed carbon materials, and oil, macadam or other surfaces which similarly impede the natural infiltration of stormwater. Open, uncovered retention/detention facilities shall not be considered as impervious surfaces for purposes of determining whether the thresholds for application of the Minimum Requirements are exceeded. Open, uncovered retention/detention facilities shall be considered impervious surfaces for purposes of runoff modeling.
Intersection	Refers to the area, joined by two (2) or more roads intersecting. For purposes of a continuous street at an acute curve or some other angle point with different street names.
Land-disturbing Activity	Any activity that results in a change in the existing soil cover (with vegetative and non-vegetative) and/or the existing soil topography. Land-disturbing activities include, but are not limited to clearing, grading, filling, and excavation. Compaction that is associated with stabilization of structures and road construction shall also be considered a land-disturbing activity. Vegetation maintenance practices, including landscape maintenance and gardening, are not considered land-disturbing activity. Stormwater facility maintenance is not considered land-disturbing activity if conducted according to established standards and procedures.
LID Manual	Low Impact Development Technical Guidance Manual for Puget Sound, December 2012

Low Impact Development (LID) BMPs	A synonym for on-site stormwater management BMPs.
MR	Ecology's Minimum Requirements
Multi-Use Trail	A pathway designated for pedestrian or bicycle use.
Native vegetation	Vegetation comprised of plant species, other than noxious weeds, that are indigenous to the coastal region of the Pacific Northwest and which reasonably could have been expected to naturally occur on the site. Examples include trees such as Douglas fir, western hemlock, western red cedar, alder, big-leaf maple, shrubs such as willow, elderberry, salmonberry, and salal, and herbaceous plants such as sword fern, foam flower, and fireweed.
NPDES	National Pollutant Discharge Elimination System
On-site Stormwater Management BMP	Distributed stormwater management practices, integrated into a project design, that emphasize pre-disturbance hydrologic processes of infiltration, filtration, storage, evaporation and transpiration. LID BMPs include, but are not limited to: BMP T7.30; Bioretention Cells, Swales, and Planter Boxes, BMP T5.14A; Rain Gardens, BMP T5.14B; Bioretention, BMP T5.15; Permeable Pavements, roof downspout controls, dispersion, BMP T5.13; Post-Construction Soil Quality and Depth, BMP T5.18; Minimal Excavation Foundations, BMP T5.17; Vegetated Roofs, and water re-uses.
Parking Lot	Any area intended to accommodate parked vehicles for free or for a fee and not necessary to single-family residences.
Permeable Pavement	PerVIOUS concrete, porous asphalt, permeable pavers or other forms of pervious or porous paving material intended to allow passage of water through the pavement section. It often includes an aggregate base that provides structural support and acts as a stormwater reservoir. Also known as a permeable pavement BMP.
Pollution-generating hard surface (PGHS)	These hard surfaces considered to be a significant source of pollutants in stormwater runoff. See the listing of surfaces under pollution-generating impervious surface.

Pollution-generating impervious surface (PGIS)	Those impervious surfaces considered to be a significant source of pollutants in stormwater runoff. Such surfaces include those which are subject to: vehicular use, industrial activities (as further defined in this glossary), or storage of erodible or leachable materials, wastes, or effluents; or storage of erodible or leachable materials, wastes, or effluents, and which receive direct rainfall or the run-on or blow-in of rainfall, mean roofs unless they are coated with an inert, non-leachable material (e.g., baked-on enamel coating); or roofs that are subject to venting significant amounts of fumes, mists, or flames from manufacturing, commercial, or other indoor activities.
Pollution-generating pervious surface (PGPS)	Any non-impervious surface subject to vehicular use, industrial activities (as further defined in this glossary), or storage of erodible or leachable materials, wastes or chemicals, and that receive direct rainfall or run-on or blow-in of rainfall, use of pesticides and fertilizers, or loss of soil. Typical PGPS include permeable pavement subject to vehicular use, lawns and landscaped areas including: golf courses, parks, cemeteries, and sports fields (natural and artificial turf).
Private Street	Any vehicular access way, designed or intended to serve three or more parcels or dwelling units or any commercial business which has not been dedicated and accepted as a public roadway.
Professional Engineer	An engineer licensed in the State of Washington
Rain Garden	A non-engineered shallow, landscaped depression, with compost-amended native soils and adapted plants. The depression is designed to pond and temporarily store stormwater runoff from adjacent areas, and to allow stormwater to pass through the amended soil profile.
Securities	Bonds, retainers, cash deposits, assigned savings, or another type of guarantee used to guarantee the performance of or correct deficient work.
sf	Square feet
Sidewalk	The portion of a street designed for preferential use by pedestrians.
Standard Drawings	City of Kelso drawings that portray the repetitive details of certain types of construction and are found in appendices to the KEDM.
Stormwater facility	A constructed component of a stormwater drainage system designed or constructed to perform a particular function, or multiple functions. Stormwater facilities include but are not limited to pipes, swales, ditches, culverts, street gutters, detention ponds, retention ponds, constructed wetlands, infiltration devices, catch basins, oil/water separators, and biofiltration swales.

Stormwater Site Plan	The comprehensive report containing all of the technical information and analysis necessary for a regulatory agency to evaluate a proposed new development or redevelopment project for compliance with stormwater requirements.
Street	A public or private way, which affords the principal means of access to abutting property.
SWM/MAW	2012 Stormwater Management Manual for Western Washington, as Amended in December 2014, by Department of Ecology.
SWPPP	Stormwater Pollution Prevention Plan.
Trail	"Trail" is synonymous with Bicycle Path (off-street pathway).
Trip Generation	The most recent calculated trip rates (either calculated by average or formula), published by the Institute of Traffic Engineers or other transportation engineering analysis proposed by an applicant and deemed appropriate by the Director.
Traffic Engineer	An individual licensed by the State of Washington to practice professional engineering who has been retained by the City or others to design roadway improvements, including utilities.
Unimproved Surface	Any surface that is not maintained or where natural vegetation is expected to grow taller than 6 inches.
Unsignalized Access Spacing	The distance between intersections that do not have traffic signals.
WAC	Washington Administrative Code.
WSDOT	Washington State Department of Transportation
Wetlands	Those areas that are inundated or saturated by surface or ground water at a frequency and duration sufficient to support, and that under normal circumstances do support a prevalence of vegetation typically adapted for life in saturated soil conditions. Wetlands generally include swamps, marshes, bogs, and similar areas. Identification and delineation of jurisdictional wetlands and wetland boundaries shall be done by a qualified biologist using applicable State and Federal guidelines.
WSDOT Standard Specifications	The latest edition of the "Standard Specifications for Road, Bridge, and Municipal Construction" as published by the Washington State Department of Transportation and the American Public Works Association.

1.03 Permits

Permits, approvals, or agreements are required by the City and sometimes by other jurisdictions, prior to initiating any construction or demolition work elements described within the KEDM.

The majority of work covered under the KEDM will require multiple permit authority review and approvals. Several types of permits and approvals require prior approval from the authority before a building or other substantial permit can be issued. Any questions regarding information about permits, approvals, and agreements should be directed to the Director.

Grading permits may be issued at the discretion of the Director between May 1st and October 1st, provided that the Director may extend or shorten this time period on a case by case basis depending on actual weather conditions. If structures are proposed to be installed in the future, the grading permit must be closed prior to issuance of a building permit.

1.04 Submittal Requirements

A. General

1. Submittal requirements consist of Civil Site Development Plan, grading plans (where required), stormwater plans and reports (where required), erosion control plans (where required), drainage calculations, geotechnical reports, and other information as required. Letters of transmittal referencing the project name shall accompany all submittals.
2. The WSDOT Standard Specifications are hereby adopted and incorporated as part of this document by reference except as modified herein.
3. General specifications for design plan sets, plan views, profile views, and details sheets to be used in all classes of submittals are given in Section B, C, D, E, and F of the KEDM.

B. Design Plan Format Specifications

Design Plan Format Specifications shall be the minimum specifications used for all plan sets requiring civil engineering, including the Civil Site Development Plan, the Stormwater Site Plan, and other plans. Some plans may have additional specifications.

1. The plans shall be electronically drafted and submitted on 22" x 34" sheets, landscape format.
2. Each Plan shall have a Cover sheet showing the following:

- a. Project name
- b. Project number, if a City project
- c. Date
- d. Vicinity map showing the location of the project in respect to the nearest major street intersection
- e. Site information including street address (if applicable), Assessor's taxlot, and/or Abbreviated Legal Description
- f. Name and mailing address of applicant/owner, engineering firm, survey firm, geotechnical engineer, and landscape architect
- g. Notice to excavators to call for locates prior to excavation
- h. Four inch by four-inch space in the lower right corner for the City of Kelso's approval stamp.
- i. The following statement shall appear on the cover sheet of all plans at a location immediately above or below the Applicant Engineer's professional stamp:
"I hereby certify that these plans, and related design, were prepared in conformance with the City of Kelso's Engineering Design Manual. I acknowledge that City approval of these documents does not transfer liability."
j. Index of sheets (Note: the index of sheets may be shown instead on a Notes and Legends sheet behind the Cover sheet.)
k. Legend that provides the name and symbol for all symbols used on the subsequent sheets. (Note: the Legend may be shown instead on a Notes and Legends sheet behind the Cover sheet. Alternatively, a legend may be placed on each sheet showing symbols used on that sheet.)
3. The scale shall be 1-inch = 5 feet vertically, and 1-inch = 20 feet horizontally for all drawings. A scale of 1-inch = 10 feet may be used for more detailed drawings such as intersection drawings. The composite utility plan may be at a smaller scale if needed. Scale shall be shown with north arrow and within a title block. All scales shall be as designated above unless otherwise approved by the Director.
4. The location and elevation of a National Geodetic Survey, United States Geological Survey, Cowitz County, or City of Kelso bench mark shall be shown. No other datum shall be used without permission of the City.

Temporary control bench marks and elevations shall also be shown on the plans.

5. A north arrow and scale bar shall be shown on each plan view sheet of the plans and adjacent to any other drawing, which is not oriented the same as other drawings on the sheet.
6. Letter size shall not be smaller than 0.10 of an inch high.
7. A title block shall appear on each sheet of the plan set. The title block shall include the name of the project, the engineering firm, the Owner, the sheet title, and the sheet number.
8. The seal of the registered Washington Professional Engineer responsible for preparation of the plans shall appear on each sheet.
9. The description and date of all revisions to the plans shall be shown on each sheet affected, and shall be approved and dated by the registered Professional Engineer of record as evidenced by an original signature or initial.
10. Through use of standard drafting symbols, indicate the location and direction of view for all sections.
11. Match lines shall have stationing and sheet number references.

C. Civil Site Development Plan Submittal

The Civil Site Development Plan is the master plan set, which can or may incorporate other required plan submittals, such as the site grading plan and the Stormwater Site Plan. At the minimum the Civil Site Development Plan shall include the following:

1. Composite utility plan: include existing public and private utilities, and proposed public improvements.
2. Approved preliminary plat (if it's a subdivision).
3. Landscape plan, if applicable, including sidewalks, bikeways, retaining walls, landscaping, irrigation, and lighting.
4. Signage and striping plan, if applicable.
5. Plan view shall show the following when applicable:
 - a. Right-of-way, property, tract, and easement lines (existing and proposed).

- b. Subdivision name, lot numbers, street names, and other identifying labels. Subdivision and street names are subject to the approval of the City Planning Director, Fire Chief, and Director.
- c. Location and stationing of existing and proposed street center lines and curb faces.
- d. Horizontal alignment and curve data of street center lines and curb returns including bearings along centerline.
- e. Existing underground utilities and trees over 6-inches in diameter within the construction limit.
- f. Location of existing buildings, wells, septic tanks, on-site sewage drain fields, fuel tanks, and any other buried structures.
- g. Location, stationing, and size of all mains and service lines for storm drainage, sanitary sewer, and water; and location of all fire hydrants. Stationing shall be located in relationship to the street stationing at all manholes or other key locations.
- h. Provisions for cross-connection control must be clearly shown on the plans, including any retro-fitting of existing water service connections and existing auxiliary water supplies, conversions to City of Kelso water service that are required as a condition of development approval, upgrading of existing service connections by replacement of same, and any other cross connection control required by state and local rules and codes.
- i. Street stationing to be noted at a minimum of 100-foot stations.
- j. Top of curb elevations along curb returns at quarter-delays and 100-foot stations.
- k. Location of the low points of street grades and curb returns.
- l. Sidewalk locations. This shall include ramps, transitions in location or width, and relationship with driveways. It shall be shown with hatching what sidewalk is proposed to be constructed with the street and what sidewalk is proposed to be constructed with the buildings.
- m. Crown lines along portions of streets transitioned from one typical section to another.
- n. Centerline stationing of all intersecting streets.
- o. Location and description of existing survey monuments, including but not limited to, section corners, quarter corners, donation land claim corners, and City bench marks.
- p. Location of proposed street intersection monument boxes.
- q. FEMA designated 100-year flood plains and flood ways, or areas of flooding during a 100-year storm event.

- r. Existing drainage and stormwater facilities, including off-site facilities, upstream and downstream that affect the design (e.g. downstream restrictions that back water onto project site). Locations of catch basins, pipes, channels, ditches, swales, culverts,
- s. Streams, springs, wetland areas, wetland buffers and other waters of the State.

t. Any additional information that the City deems necessary.

6. Profile views shall show the following:

- a. Stationing, elevations, vertical curve data (including curve k factors), and slopes for center of streets or top of curbs. For offset or super elevation cross-sections, both curbs shall be profiled. Where curbs are not to be constructed, center line of street and ditch inverts shall be shown.
- b. Original ground along the center line, and if necessary at the edges of the right-of-way if grade differences are significant.
- c. Center line, top of curb, and gutter flow lines of existing streets for a distance of at least 300 feet each way at intersections with proposed streets. For stub streets that may be extended in the future, the vertical alignment shall be designed for at least 300 feet beyond the scope of the proposed construction, unless otherwise approved by the Director. At the discretion of the Director, additional design information concerning the vertical and horizontal alignment of future street extensions may be required.
- d. Vertical alignment of streets, including existing center line monumentation.
- e. The top of curb for all cul-de-sacs, eye-brows, and curb returns.
- f. Profiles of existing drainage and stormwater facilities, including off-site facilities, upstream and downstream that affect the design (e.g. downstream restrictions that back water onto project site). In addition, base flood elevations shall be shown on the profile.
- g. All proposed drainages and stormwater facilities; all invert and top elevations, slopes, direction of flow, materials, bedding, and backfill.
- h. Profiles for ditch and creek flowlines shall extend a minimum of 200 feet beyond the project, both upstream and downstream, with typical cross sections at 50-foot intervals, unless otherwise approved by the Director.
- i. Designator structures using alpha or numeric labels on profiles to correspond to plan view notation.
- j. Profile for existing and proposed storm, sanitary, and water mains.
- k. All existing and proposed sanitary, water, storm lines, and other utilities crossing the profile.

7. Detail sheets

Detail sheets shall be provided as part of the Site Development Plans and other required plans. The detail sheet(s) shall show all City Standard Details and special details necessary for the project. The detail sheet(s) shall show all City Standard Notes applicable to the project.

All Details shall be full size.

D. Site Grading Plan Submittal

The City of Keiso requires a site grading plan as part of the application for any development that involves the excavation or fill of greater than 50 cubic yards of material or the disturbance of 7,000 square feet or more of land (land-disturbing activity). Grading contours (existing & proposed) shall be at no more than 2-foot intervals. Existing contours shall extend beyond the project site a minimum of 50 feet. Existing contours and elevations on the grading plan shall be prepared, stamped and sealed by a surveyor licensed in the State of Washington.

All land-disturbing activity must adhere to the requirements of Chapter 2 for erosion and sedimentation control.

E. Structural Submittal

Structural construction plans and the necessary calculations stamped by a structural engineer shall be submitted for proposed structures, as determined by the Director (i.e. walls, box culverts, bridges). A letter from the structural engineer approving installation of the structure shall be submitted prior to as-built approval.

F. Other Requirements

Other information to be shown on the construction drawings or other submittals includes:

1. The design elements such as:
 - a. Street classification;
 - b. Design speed;
 - c. Super elevation;
2. For construction sites that disturb one or more acres of land, or are part of a larger common plan of development or sale that eventually will disturb one or more acres of land, submit a copy of the Notice of Intent for the Construction Stormwater General Permit the applicant or Applicant Engineer submitted to

Ecology. If the site was granted a waiver by Ecology, submit a copy of the waiver instead.

3. Any additional information that the Director deems necessary to review the plans and assure compliance with design standards.

G. Stormwater Submittals Guide

Development projects and land-disturbing activities that exceed the thresholds in Chapter 2 of the KEDM are required to prepare and submit a Stormwater Site Plan. The Stormwater Site Plan encompasses the entire submittal for stormwater and drainage review.

Depending on the size and complexity of the development or activity, applicants must prepare either an Abbreviated Stormwater Site Plan or a Full Stormwater Site Plan. The size and complexity are evaluated using the applicability criteria found in Chapter 2 of the KEDM.

1. Abbreviated Stormwater Site Plan

Sites that trigger MRs 1-3 in accordance with Chapter 2 of the KEDM shall prepare an Abbreviated Stormwater Site Plan. The Abbreviated Stormwater Site Plan meets the requirements of MR 1.

To fulfill this requirement, applicants shall complete the Abbreviated Stormwater Site Plan form available from the City and shall provide the required attachments.

2. Full Stormwater Site Plan

Sites that trigger MRs 1-9 in accordance with Chapter 2 of the KEDM shall prepare a Full Stormwater Site Plan. The Full Stormwater Site Plan fulfills MR 1.

To prepare the elements of a Full Stormwater Site Plan, applicants shall follow the instructions for Preparation of Stormwater Site Plans in Section 2.05 of the KEDM.

Individual elements produced by following the instructions in Section 2.05 shall be organized into the following four separate documents, which comprise the Full Stormwater Site Plan:

- a. Site Development Drawings (see specifications in Section H, below)
- b. Drainage Design Report (see specifications in Section I, below)

- c. Long-Term Stormwater Site Management Plan (see specifications in Section J, below)
- d. Construction Stormwater Pollution Prevention Plan (see specifications in Section K, below)

Specifications for each of these documents are given in Sections H through K below.

H. Specifications for Site Development Drawings

The Site Development Drawings must meet the specifications of the Civil Site Development Plan in accordance with Section 1.04.C of the KEDM. The Site Development Drawings are engineering drawings that provide sufficient detail to construct the project's stormwater facilities and conveyances. These plans shall be stamped, signed, and dated by the engineer(s) registered in the State of Washington, responsible for the civil engineering design of the project.

1. The following specifications apply in addition to the Civil Site Development Plan Specifications:

- a. Include a survey meeting the requirements of the SWNGM/WV Vol. I Section 3.1.1.1 on pages 3-4 for projects required to meet MRs 1-9.
- b. Threshold discharge areas in accordance with Chapter 2 of the KEDM. TDAs shall be identified and labeled consistently in all submittals – plans, reports, and maps.
- c. Location of the point of stormwater and surface water discharge from each TDA, which preserves natural drainage patterns.
- d. Location and overflow route for the 100-year storm.
- e. Location of soil logs, test pits, and extents of soils as documented in the Drainage Design Report.
- f. Location of slope instability and steep slopes.
- g. Areas of the site predominantly covered by native vegetation and areas of native vegetation to be preserved.
- h. Existing and proposed stormwater drainage: offsite areas contributing runoff to the site; location and number of stormwater facilities and on-site stormwater BMPs; designated flow paths and dispersion areas; direction of flow; size, type and kind of drainage channels and pipes.
- i. Existing and proposed pollution-generating pervious surfaces (PGPS) and pollution-generating hard surfaces (PGHS).
- j. Location of on-site stormwater BMPs (MR 5).

- k. Include locations of on-site BMPs on individual lots if they are used to meet MRs 6 or 7.
 - l. Show areas of disturbed soils to be amended (BMP TS.13)
 - m. Location of all runoff treatment facilities (MR 6)
 - n. Location of all flow control facilities (MR 7)
 - o. Location of structural source control BMPs used to meet MR 3.
 - p. Dimension of permeable pavements. Drawings shall use different hatches for permeable pavement and traditional pavement.
 - q. Dimensions of setbacks of stormwater facilities and on-site stormwater BMPs from property lines, structures, wells, on-site sewer systems, landfills, slopes, and other natural features as applicable to the facility.
 - r. Locations and species of retained trees and newly planted trees for which impervious surface reductions are claimed. Show distance from associated impervious surface.
 - s. Show all trends or easements used to enclose drainage features or stormwater facilities.
 - t. If individual lots will connect to the public stormwater drainage system, locations of approved connections.
 - u. Approved location for storm runoff from building lots (if applicable)
 - v. The Director may require additional site or vicinity information if needed.
 - w. Include in the landscape plan:
 - x. Locations and dimensions of vegetated stormwater facilities and vegetated on-site stormwater management BMPs
 - y. Locations and dimensions of areas of preserved native vegetation
 - z. Locations and species of retained trees Locations and dimensions of any required flow lengths and vegetated flow paths, (e.g. for dispersion BMPs)
 - aa. Detailed planting plan and specifications for trees, vegetated stormwater facilities, and vegetated on-site stormwater management BMPs
2. The following additional Profile specifications apply:
 - a. Original surface grade profile
 - b. Final surface and storm drain profile
 3. The following additional Detail specifications apply:
 - a. Details of each biocontrol BMP showing the following:

- i. Width, length, side slopes, and maximum design pond depth. If biocontrol is used to meet MR 6 or MR 7, show sufficient details to confirm accurate representation of the facility in the continuous simulation hydrologic model.
 - ii. Descriptions of all materials such as underdrain, drain rock, pipe, filter fabric, outlet structure, irrigation, biocontrol soil mix, and mulch
 - iii. Locations, elevations, and slopes of any catch basins and pipes
 - iv. Designs for any retaining walls proposed. Structural walls shall meet City building permit requirements.
 - v. A minimum of two cross-sections showing original property lines, slope catch points and other information to construct the facility
- b. Details of each permeable pavement installation showing the following:
 - i. Dimensions of permeable pavement
 - ii. Dimensions of underground storage layer. If permeable pavement is used to meet MR 6 or MR 7, show sufficient details to confirm accurate representation of the facility in the continuous simulation hydrologic model.
 - iii. Pavement section
 - iv. Descriptions of all materials such as geotextile; underdrain; base material; storage layer; asphalt, concrete, or pavers
 - v. Direction and percentage of slope
 - c. Details of each treatment facility showing the following:
 - i. Overall measurements and dimensions
 - ii. Flow direction
 - iii. Location and elevations of inverts, inflow, bypass, and discharge
 - iv. Slope (if applicable)
 - d. Details of each flow control facility showing the following:
 - i. Overall measurements and dimensions
 - ii. Measurements necessary to calculate storage volumes
 - iii. Control structure/restrictor placement
 - iv. Details of flow control structures showing size, dimensions, elevations, and orientations of all orifices, weirs, risers, tee-sections, etc.

- v. A minimum of two cross-sections of each infiltration or detention pond showing original property lines, slope catch points, and other information to construct the facility.
- e. Details of each on-site stormwater BMP used to meet MR 5 sufficient to construct the BMP.
- f. For infiltration facilities and on-site stormwater BMPs used to infiltrate runoff from a pollution-generating hard surface, provide details to confirm accurate representation in the continuous simulation hydrologic model (see Drainage Design Report).

1. Specifications for Drainage Design Report

The Drainage Design Report contains the technical information to support the site's drainage and stormwater plan. The report shall contain the following sections and components and shall address MRS 1-9.

All sections listed below shall be included in each Drainage Design Report. If a section is not applicable, write "N/A" in the section contents and describe why the section is not applicable.

All page numbers of the report shall be numbered. Appendices shall have page numbers.

1. Cover Page

The Cover Page shall contain the following items:

- a. Name of Report
- b. Project Name
- c. Project Number, if a City project
- d. Situs Address
- e. Applicant's Name and Contact Information
- f. Applicant Engineer's Name and Contact Information
- g. Date of Submittal

2. Applicant Engineer's Certification

The Applicant Engineer shall include a statement that all the required information is included in the Drainage Design Report, the report was prepared by the Applicant Engineer or under his/her supervision, and that the proposed stormwater facilities are feasible.

3. Table of Contents

The Table of Contents shall contain the following items:

- a. List of section headings and their respective page numbers
- b. List of tables with page numbers
- c. List of figures with page numbers
- d. List of attachments and/or appendices, numbered
- e. List of references

4. Maps

All maps shall contain a scale and north arrow. The following maps shall be included:

- a. **Vicinity Map:** All vicinity maps shall clearly show the project site.
- b. **Basin Maps:** Show project boundaries, sub-basin boundaries, TDAs, and off-site contributing areas for both the pre-development and the post-development scenarios. TDAs shall be identified and labeled consistently in all submittals – plans, reports, and maps. Show drainage features, the flow path to and from the project site, and stormwater treatment and flow control facilities. Identify the point of compliance of each TDA for modeling site hydrology using an approved continuous simulation hydrologic model.
- c. **Soils Map:** The soils map shall show soils on the site and within the contributing area that drains to the site itself. Information should be consistent with the Soils Report.
- d. **Other Maps:** The following additional maps shall be required in the situations noted:
 - i. **Wellhead Protection.** If the site lies within the 10-year time-of-travel zone of a public water supply well or within a Category I or II critical aquifer recharge area (CARA), maps showing all of the zones of contribution that overlap the site are required.
 - ii. **Floodplains.** If a floodplain mapped by the Federal Emergency Management Agency (FEMA) exists on or adjacent to the site, a map showing the floodplain is required.
 - iii. **Shoreline Management Area.** If the site requires a shoreline permit, a map showing the boundary of the shoreline management area in relation to the site is required.

5. Section A – Project Overview

The Project Overview is a brief narrative describing and summarizing the site and the proposed project. Most of the information in the Project Overview is discussed or shown in detail in other sections of the Stormwater Site Plan.

- a. Describe the site location, including legal description, address, parcel number, zoning, etc.
- b. List the primary type of permit required for the work and briefly summarize the type of development project.
- c. Summarize the existing conditions including topography, natural drainage patterns, vegetative ground cover, presence of agricultural drain tiles, and presence of critical areas.
- d. List existing onsite stormwater systems and describe their functions.
- e. Summarize site parameters that influence stormwater system design.
- f. List adjacent areas, including streams, lakes, rivers, wetland and buffer areas, residential areas, and roads that might be affected by the construction project.
- g. Generally describe proposed site construction, size of improvements, and proposed methods of mitigating stormwater runoff quantity and quality impacts.
- h. Describe how the proposed project considers the six listed site layout considerations described in SWMM/WV, Vol. I, Section 3.1.2, Step 2 – Prepare Preliminary Development Layout.
- i. Describe other permits from City of Keiso and/or other agencies that may affect the design of the stormwater system. Describe how any conditions will be managed.

6. Section B – Existing Conditions and Soils

Provide a detailed narrative of the site's survey, using the information gathered in Step 1 – Site Analysis: Collect and Analyze Information on Existing Conditions in SWMM/WV, Vol. I Section 3.1.1.

Provide a detailed narrative of the soils and subsurface investigations also required in SWMM/WV, Vol. I, Section 3.1.1. Describe the soils on the site.

Attach the required Soils Report as an appendix to the Drainage Design Report.

At a minimum, include the following:

- a. Existing ground cover, including pervious and developed areas

- b. Drainage through the site and to and from adjacent properties
- c. Locate and describe point of discharge from the site
- d. State whether the site is located in a drainage district
- e. Describe streams, rivers, ponds, ravines, gullies, steep slopes, springs, and erosion hazards on or downgradient of the site
- f. Describe critical areas on the site and those that receive runoff from the site to a minimum of ¼ mile away from the site boundary
- g. For agricultural sites with drain tiles, discuss the impact on site drainage
- h. Location of or proximity to high groundwater
- i. Location of or proximity to aquifer recharge areas or wellhead protection areas
- j. Describe known drainage problems such as flooding, erosion
- k. Describe location and proximity to structures, basements, property lines, sewers, septic tanks and drain fields, closed or active landfills, and storage tanks, both aboveground and underground
- l. References and describe any relevant reports or studies such as geotechnical reports on the site or adjacent to it, environmental impact statement, critical areas reports, flood studies, or basin plans. Describe any conditions imposed on the site or development activity by such reports or studies.
- m. Describe the soils on the site, using information included in the required Soils Report.
- n. Describe the infiltration testing done to assess the feasibility of bioretention and permeable pavement.
- o. State the results of the results of testing for saturated hydraulic conductivity, the results of testing for a hydraulic restriction layer, water table elevations, and results of analysis of shallow lateral flow (if needed).
- p. If full dispersion is proposed for the site, provide a narrative of the native vegetation survey required in SWMM/WV, Vol. I, Section 3.1.1.

- * Attach the survey as an appendix to the Drainage Design Report.

7. Section C – Minimum Requirements Analysis

Following instructions in SWMM/WV, Vol. I, Section 3.1.4 to determine and read the MRS, describe the land-disturbing activity and document the applicable MRS for the project site. See Chapter 2 of the KEDM for requirements.

- a. Provide a table to document the totals of land-disturbing activities and surfaces on the post-development site in the following categories:
- i. The amount of existing hard surface.
 - ii. The amount of new hard surface.
 - iii. The amount of replaced hard surface.
 - iv. The amount of vegetation converted to lawn or landscaping.
 - v. The amount of native vegetation converted to pasture.
 - vi. The total amount of land-disturbing activity.
 - vii. The total amount of PGHS
 - viii. The total amount of PGPS, not including permeable pavements
 - ix. The total amount of effective impervious surface
- If the site includes multiple TDAs, provide this same information for each TDA and aggregated for the entire site.
- b. Document through an approved continuous simulation hydrologic model the increase in the 100-year flood frequency from pre-developed to developed conditions for each TDA.
- c. List the proposed commercial or industrial uses of the site, if any.
- d. Based on the information above and on an understanding of the MRS:
- i. List the TDAs that must meet the on-site stormwater management requirements listed in MR 5.
 - ii. List the TDAs that must meet the water quality requirements listed in MR 6.
 - iii. List the TDAs that must meet the flow control requirements listed in MR 7. List which, if any, are also Flow Control Exempt.
 - iv. List the TDAs that must meet the wetlands protection requirements listed in MR 8.
 - v. List the TDAs that must meet the pollutant source control requirements listed in MR 9.
8. Section D – On-Site Stormwater Management Selection and Sizing (MR 5)
- Describe how the site meets the requirements of on-site stormwater management listed in MR 5.
- Information and calculations in the Drainage Design Report shall support and be consistent with the Site Development Drawings. All on-site stormwater management BMPs shall be shown on the Site Development Drawings (1.02.F).

At a minimum, include the following in the Drainage Design Report:

- a. Describe the site's suitability for on-site stormwater management.
- b. For each TDA, state whether MR 5 is being met using List #2 or the LID Performance Standard.
- c. Provide a narrative describing how the project will fulfill the requirement for on-site stormwater management (MR 5) to the extent feasible.
- d. List total area of native vegetation retained.
- e. List the on-site stormwater management BMPs selected.
- f. Show an illustrative sketch of the on-site stormwater plan.
- g. Describe site suitability, including soils, slopes, infiltration rate, and native vegetation, as applicable, for each on-site stormwater management BMP.
- h. Describe how design criteria will be met for each on-site stormwater management BMP.
- i. Describe specifications for amending disturbed soils in accordance with BMP TS-13.
- j. Summarize proposed ownership of on-site stormwater management BMPs [Additional details to be provided in the Long-Term Stormwater Site Management Plan.]

If Using List #2

- k. Provide justification and documentation, if needed, for any determination that an on-site stormwater management BMP is infeasible. The only acceptable infeasibility criteria are found in the SWMMWW. Site-specific information is required.

If Using the LID Performance Standard

- l. Show calculations for impervious surface reduction credits for retained or newly planted trees, if any.
- m. If fill dispersion or fill downspout infiltration are proposed, describe how BMP designs meet requirements allowing removal of the associated drainage areas from computer model input.
- n. Complete a detailed hydrologic analysis for existing and developed site conditions, in accordance with the requirements of SWMMWW, Vol. III, Section 2, using an approved continuous simulation hydrologic model. Compare pre-developed and developed flow durations for all TDAs. Provide an output table from the continuous flow model, including the following:

- i. Flow rates for the 2, 10, and 100-year return periods for pre-developed and developed conditions.
 - ii. A table listing the pass/fail rates for each flow level whose duration statistics were calculated.
 - iii. A graph showing the flow rate on the y axis and percent time exceeding on the x axis for pre-developed conditions and post-developed mitigated conditions, from 8% of the 2-year through the 50% of the 2-year flow rate.
- o. Provide the electronic computer model input and output files on a CD or a USB flash drive. [Note: the media will not be returned.]

II. Using Bioretention

- p. Describe the bioretention soil mix specifications.

II. Using Permeable Pavement

- q. Show supporting design calculations showing adequate infiltration rates to accommodate flows from all surfaces directed to the permeable pavement.
- r. Base material gradation.
- s. Asphalt or concrete mix design and void calculations.
- t. Acceptance test procedures.

9. Section E – Runoff Treatment, Analysis and Design

Describe how the site meets the requirements for runoff treatment listed in MR 6. Provide a separate analysis for each TDA required to meet MR 6.

Information and calculations in the Drainage Design Report shall support and be consistent with the Site Development Drawings. All runoff treatment facilities shall be shown on the Site Development Drawings (1.02.H). A detail drawing shall be provided in the Site Development Drawings for each runoff treatment facility.

At a minimum, include the following in the Drainage Design Report:

- a. Document the level of treatment required; list the water quality menus used.
- b. Document assumptions about roofs, driveways, and other hard surfaces to be constructed after site development (e.g. in a subdivision)
- c. Provide background and description to support the selection of the treatment BMPs being proposed
- d. List the BMPs used in the design

- e. Show an illustrative sketch of the runoff treatment plan
- f. Complete a detailed analysis and design of all proposed runoff treatment system elements, in accordance with SWMM/W, Vol. V, Reference runoff treatment system elements to labeled points shown on the Site Development Drawings.
- g. Show model printouts, calculations, equations, references, and graphs as necessary to show facilities are designed consistent with the SWMM/W, Vol. V and the minimum volume criteria of MR 6.
- h. Summarize the results of the runoff treatment design and describe how the proposed design meets the requirements of the SWMM/W.
- i. If bioretention or infiltration below PGHS are used to meet the treatment requirement, the runoff model output file must include the volume of water that has been treated through these BMPs.
- j. If infiltration is used to meet runoff treatment requirements, document how the facility design and the site's soils meet the Site Suitability Criteria as described in the SWMM/W, Vol. III, Section 3.3.7.
- k. Include and reference in the Appendices all computations, equations, charts, nomographs, detail drawings, and other tabular or graphic aids used to design water quality system elements.
- l. Provide the electronic computer model input and output files on a CD or a USB flash drive. [Note: the media will not be returned.]

10. Section F – Flow Control Analysis and Design

Describe how the site meets the requirements for flow control listed in MR 7 and provision of wetland hydrology from MR 8, if applicable. Provide a separate analysis for each TDA required to meet MR 7 and/or MR 8.

Information and calculations in the Drainage Design Report shall support and be consistent with the Site Development Drawings. All flow control facilities shall be shown on the Site Development Drawings (1.02.H). A detail drawing shall be provided in the Site Development Drawings for each flow control facility.

At a minimum, include the following in the Drainage Design Report:

- a. Describe the assumptions and site parameters used in determining the pre-development site hydrology, including acreage, soil types, and land covers. Include any maps, exhibits, graphics, and references contributing to the analysis.
- b. Identify initial conditions, including stream base flows, beginning water surface elevations, hydraulic or energy grade lines, initial groundwater elevations, beginning storage volumes, and other data or assumptions

- used to complete the analyses of initial conditions. Reference the sources of information.
- o. Document assumptions about roofs, driveways, and other hard surfaces to be constructed after site development (e.g. in a subdivision)
- d. Describe use of flow control credits from on-site stormwater management BMPs
- e. Refine the site's suitability for stormwater infiltration for flow control, as described in the Soils Report.
- f. Identify and describe geotechnical or other studies and critical areas reports used to complete the analysis and design
- g. List the flow control facilities used in the design
- h. Show an illustrative sketch of the flow control facilities and their appearances and state their storage volumes
- i. Describe the approximate location and sizing of each flow control facility
- j. Include any bioretention and permeable pavement BMPs to be installed on individual lots by subsequent contractors, if these BMPs contribute to meeting the Flow Control Standard
- k. Complete a detailed hydrologic analysis for existing and developed site conditions, in accordance with the requirements of SWMMVW, Vol. III, Section 2, using an approved continuous simulation hydrologic model. Compute pre-developed and developed flow durations for all TDAs. Provide an output table from the continuous flow model, including the following:
 - i. Flow rates for the 2, 10, and 100-year return periods for pre-developed and developed conditions.
 - ii. A table listing the pass/fail rates for each flow level where duration statistics were calculated.
 - iii. A graph showing the flow rate on the y axis and percent time exceeding on the x axis for pre-developed conditions and post-developed mitigated conditions, from 50% of the 2-year through the 50-year flow rate.
 - iv. Include models and calculations demonstrating protection of wetland hydrology in accordance with MTR 8, if applicable.
- l. Provide a hydraulic analysis of pipes and/or channels that lead to and/or from the outlet structure. The analysis should confirm the capacity of pipes and channels to convey the peak flow rates for the 2, 10, 50, and 100-year return period flow rate with the water surface elevation of the pond at the elevation for those return period flow rates.

- m. Include and reference all hydrologic and hydraulic computations, equations, rating curves, stage/storage/discharge tables, graphs, and any other aids necessary to clearly show the methodology and results.
- n. Include all maps, exhibits, graphics, and references used to determine existing and developed site hydrology.
- o. Summarize the results of the flow control design and describe how the proposed design meets the requirements of the SWMMVW, including MTR 7 and, if applicable, MTR 8.
- p. Identify locations and species of newly planted or retained trees for which impervious surface reduction credits are claimed. Show calculations for impervious surface reduction credits.
- q. If full dispersion or full downspout infiltration are used, describe how BMP designs meet requirements allowing removal of the associated drainage areas from computer model input.
- r. Attach computer model printouts, calculations, equations, references, and graphics as necessary to show facilities are designed consistent with the SWMMVW, Vol. III and the Flow Control Performance Standard of MTR 7.
- s. Provide the electronic computer model input and output files on a CD or a USB flash drive. [Note: the media will not be returned.]

11. Section G – Conveyance System Analysis and Design

Describe how the site meets the requirements for conveyance from KEDM Sections 2.08, 2.09, and 2.10.

Information and calculations in the Drainage Design Report shall support and be consistent with the Site Development Drawings. All conveyances shall be shown on the Site Development Drawings (1.02.H). A profile drawing of each proposed conveyance shall be provided with the Site Development Drawings. A detail drawing of each catch basin, manhole and/or other structures required to construct the project's conveyance, as shown in the City Standard Details, shall be provided with the Site Development Drawings.

At a minimum, include the following in the Drainage Design Report:

- a. An analysis of on-site hydrologic connectivity of surface conveyance channels and pipes and points of concentration
- b. Results of the off-site analysis (see SWMMVW, Vol. I, Section 2.6.2)
- c. Describe the upstream contributing basin and any assumptions used to determine the full build-out conditions

- d. Identify and discuss initial conditions, including stream base flows, beginning water surface elevations, hydraulic or energy grade lines, beginning storage elevations, and other data or assumptions used to complete the analyses of initial conditions. Reference the sources of information.
 - e. Describe locations and dimensions of conveyance features
 - f. Complete a detailed hydraulic analysis of all proposed collection and conveyance system elements and existing collection and conveyance elements, including outfall structures and outlet protection that influence the design or are affected by the proposal, in accordance with KEDM Section 2.08 through 2.10. Identify, compute, reference, verify, summarize, and tabulate the following:
 - i. Design flows and velocities and conveyance element capacities for all conveyance elements within the development.
 - ii. The 10-year recurrence interval stage for detention facility outfalls. Provide stage-frequency documentation from the approved continuous simulation hydrologic model.
 - iii. The existing 100-year floodplain elevations and lateral limits for all channels, and no net loss of conveyance or storage capacity from development.
 - iv. The conveyance system elements to labeled points shown on the Site Development Drawings.
 - v. The capacity of each conveyance system element to convey design flow and discharge at non-erosive velocities and the capacity of the onsite conveyance system to convey design flows that result from ultimate build-out of upstream areas.
 - vi. All hydraulic computations, equations, pipe flow tables, flow profile computations, charts, nomographs, detail drawings, and other tabular or graphic aids used to design and confirm the performance of conveyance systems.
 - vii. The results of system analyses, and how the proposed design meets the requirements of the KEDM.
 - g. Document approval of the diking district to discharge to its facilities, if applicable.
12. Section H – Source Control
- If the development activity requires source control (MR 3), identify the source control BMPs to be used.
- Show any structural source control BMPs on the Site Development Drawings, and include all details needed to construct the facility.

13. Section I – Ongoing Operation and Maintenance

Summarize legal instruments needed to guarantee preservation of the drainage system and access for maintenance. List intended ownership and responsibility for operating and maintaining stormwater treatment and flow control facilities and on-site stormwater management BMPs. Describe dedications, tracts, easements, and agreements.

Additional details and attachments shall be included with the Long-Term Stormwater Site Management Plan.

14. Section J – Groundwater Monitoring Program

Where required by the City, a groundwater monitoring program shall be included in the Drainage Design Report. The groundwater monitoring program shall be prepared by a person with expertise in groundwater contamination investigation, prevention, and monitoring and shall clearly describe a comprehensive groundwater testing and evaluation program designed to ensure compliance with federal and state of Washington laws and the KEDM. The Director will review proposed groundwater monitoring programs on a site-specific basis.

15. Section K – Appendices

Provide a technical appendix that includes all computations completed in the preparation of the Drainage Design Report, together with copies of referenced data, charts, graphs, nomographs, hydrographs, surge-storage discharge tables, maps, exhibits, and all other information required to clearly describe the on-site stormwater management, flow control, and runoff treatment design for the proposed development activity. The format of the technical appendix shall follow as closely as possible the section format of the Drainage Design Report and shall be adequately cross-referenced to ensure that the design may be easily followed, checked, and verified. The technical appendix shall also contain all special reports and studies. Additional required subjects of special reports may include, but are not limited to:

- a. Geotechnical
- b. Wetlands
- c. Floodplains and floodways
- d. Groundwater
- e. Structural design
- f. Fluvial geomorphology (erosion and deposition)

J. Specifications for Long-Term Stormwater Site Management Plan

The Long-Term Stormwater Site Management Plan assures continued operation and maintenance of the site's stormwater management facilities to maintain intended function. The plan size must be 8.5" x 11" and the plan must comply with the recording standards of the Cowlitz County Auditor.

The Long-Term Stormwater Site Management Plan is a standalone plan that must be understandable by a typical property owner and site operator. It includes illustrative and narrative guidance for locating, operating, and maintaining all elements of the site's stormwater management and drainage strategy.

All sections listed below shall be included in each Long-Term Stormwater Site Management Plan. All page numbers of the plan shall be numbered. Attachments shall have page numbers.

1. Cover Sheet
- The Cover Sheet shall contain the following items:
 - a. Name of Plan
 - b. Project Name
 - c. Project Number, if a City project
 - d. Situs Address
 - e. Applicant's Name and Contact Information
 - f. Applicant Engineer's Name and Contact Information
 - g. Date of Submittal

2. Operations and Maintenance Summary

Generally describe the drainage and stormwater management facilities on the site.

Summarize the ownership and operational and maintenance responsibility of the site's drainage and stormwater control features. Describe drainage easements and stormwater treats, if any, include all types of on-site stormwater management BMPs used on the site, including retained and newly planted trees, and areas of native vegetation retained for full dispersion. Include treatment and flow control facilities. If MR 3 is applicable, include a summary of pollutant source control measures.

If the site is a subdivision, and if on-site stormwater management BMPs to be located on individual lots contribute to meeting MK 6 or MR 7, then include those BMPs in the summary.

The summary shall be consistent with the attachments that describe ownership and operation and maintenance in detail.

3. Stormwater Improvement Restrictive Covenants
- Attach a copy of the Stormwater Improvement Restrictive Covenant required by KEDM Section 2.21.C.

4. Site Stormwater System Manual
- Attach the Site Stormwater System Manual, which describes ongoing operation and maintenance of the storm drainage system, required by KEDM Section 2.21.D(1).

5. Individual Lot Operation and Maintenance Instructions
- If the site is a subdivision or short subdivision, prepare, but do not attach, simplified maintenance instructions for on-site stormwater management BMPs on individual residential lots as required by KEDM Section 2.21.D(2) for each lot. These documents shall be recorded with the Stormwater Improvement Restrictive Covenant for each lot.

Write "See recorded Stormwater Improvement Restrictive Covenant for catch lot" in this section of the plan.

If the site is not a subdivision, write "N/A" in this section of the plan.

6. Pollution Source Control Plan
- If MR 3 is applicable to the site, describe the applicable (mandatory) operational source control BMPs as described in the SWMMWW, Vol. IV Section 2.1.

K. Specifications for Construction Stormwater Pollution Prevention Plan

The Construction Stormwater Pollution Prevention Plan (C-SWPPP) describes the operational practices and structural BMPs that prevent erosion on construction sites and prevent sediment from leaving sites and entering into the drainage system.

Submit a C-SWPPP prepared in accordance with the SWMMWW, Vol. II, Chapter 3. BMPs shall be selected from the SWMMWW, Vol. II, Chapter 4.

At the minimum include the following:

1. Narrative meeting the requirements of SWMMWW, Vol. II, Section 3.2.1
2. Drawings meeting the requirements of SWMMWW, Vol. II, Section 3.2.2

L. Transportation Impact Study

1. Purpose: The transportation impact study is an analysis prepared to determine the transportation impacts of a given development.
2. Timing: A transportation impact study shall be submitted with the land use application as required in KEDM Section 1.04.K.
3. Contents: The transportation impact study will typically include the following. The Director may require more or less depending on the size and/or anticipated impacts of the development as required in KEDM, Section 3.01.
 - a. Analysis approach and methods - The traffic study approach and methods should be guided by the following criteria:
 - (i) Study Area - As a rule, the analysis must include any intersection or roadway segment, regardless of jurisdictional boundaries, to which at least 10 project trips would be added during the peak hour of trip generation (or 100 daily trips). Projects just meeting the minimum threshold for traffic impact analysis will normally require analysis of only the intersection(s) or roadway segment(s) adjacent to the site. Larger developments will require the analysis of more intersections. Some larger developments will require application of the urban area traffic model which is developed and maintained by the Cowliwiz-Wahkikam Council of Governments. In addition to off-site intersections, it is important that the TIA address the intersections/driveways proposed to provide access to the site. The Director must approve the study intersections and roadways.
 - (ii) Study Horizon Years - The study horizon year shall be the year the project is to be completed and operational. If the project requires a zone change, the horizon year shall be ten (10) years from the date of the study, and include a "no-build" analysis for comparative purposes.
 - (iii) Analysis Time Period - Both the morning and evening weekday peak hours, 7:00 a.m. to 9:00 a.m. and 4:00 p.m. to 6:00 p.m., shall be analyzed, unless the proposed project is expected to generate no trips, or a very low number of trips, during either the morning or evening peak periods. If this is the case, the requirement to analyze one or both of these periods may be waived by the Director. Where the peak traffic hour in the study area occurs during a different time period than the normal morning or afternoon peak travel periods (for example mid-day), or occurs on a weekend, or if the proposed project has unusual peaking characteristics, it is up to the

discretion of the Director if these time periods should be included for analysis.

- (iv) **Geometrics and Traffic Control** - Roadway geometric conditions within the study area should include, but not be limited to, intersection and driveway spacing, roadway width, traffic lanes, turn lanes, medians, curb and gutter, speed limits, horizontal and vertical curvatures, traffic control devices and traffic signal phasing (if traffic signals are present). The discussion on geometric conditions should include locations of driveways and intersections across the street from the development and how this may impact traffic operations.
- (v) **Sight Distance** - To identify potential safety issues associated with site access and egress, sight distance at intersections (stopping sight distance and corner sight distance) measurements shall be conducted at the proposed site driveway(s). The measured sight distance shall be compared to minimum requirements, as established by the American Association of State Highway and Transportation Officials (AASHTO). A summary of sight distance analysis should be presented in tabular form and included in the TIA.
- (vi) **Traffic Volumes** - When directed by the City's representative, the traffic volumes for the analysis hours should be adjusted for the peak season, in cases where seasonal traffic data is available.
 - (A) **Data Collection Requirements** - All data should be collected in accordance with the latest edition of the ITE Manual of Traffic Engineering Studies.
 - (B) **Turning Movement Counts** - Manual turn movement counts shall be collected at all study area intersections to determine the base traffic conditions. These turning movement counts should typically be conducted during the weekday (Tuesday through Thursday) between 7:00 a.m. - 9:00 a.m. and 4:00 p.m. - 6:00 p.m. and for other periods depending upon the proposed and/or surrounding land uses. Historical turning movement counts may be used if the data is not more than 12 months old at the time of the TIA. In high traffic locations where congestion is present or traffic peaks early or late, extended or altered count periods may be required. Turn movement counts may be required during other periods as directed by the City's representative.

- (C) **Daily Traffic Volumes** – Daily traffic volumes should be provided as 24-hour volumes (one hour increments), and peak period volumes (15 minute increments) at intersections and driveways should be provided as turning movements. The analysis shall be based on traffic counts that are no more than 12 months old (or less if there are significant changes in traffic patterns). If current traffic volume data is not available from the City, the consultant shall be responsible to collect all necessary data. The estimation of existing peak hour turn movements based on automatic machine counts is not acceptable.
- (D) **Pedestrian and Bicycle Volumes** – Pedestrian and bicycle data will be included with all peak period intersection turn movement counts. Pedestrian data will be collected for each crossing movement of each leg of the intersection, while bicycle data will be collected by approach leg of the intersection.
- (vi) **Crash Data** – Within the study area for each TIA, a crash history evaluation shall be conducted for the most recent three-year period. The intent of the evaluation is to identify any apparent trends in the data that reflect a safety issue that may be exacerbated by the proposed development and to identify mitigation(s) to resolve the issue(s). At a minimum, the analysis shall summarize the number of crashes per year, location of crash (intersection), direction of the vehicles, type of crash, severity and fatalities. Any pedestrian and/or bicycle collisions within the corresponding analysis period should be identified separately. Intersection crash rates shall be calculated and evaluated based on estimated million entering vehicles at the intersection. The Traffic Engineer shall assess the overall results of the safety analysis. The Director may request a crash diagram be drawn.
- (vii) **Traffic Volume Forecasts** – Future traffic volumes should be estimated using information from transportation models, or applying an annual growth rate to the base-line traffic volumes. The future traffic volumes should be representative of the horizon year for project development. If the annual growth rate method is used, the Director must give prior approval to the growth rate. In addition, any nearby proposed approved development projects should be taken into consideration when forecasting future traffic volumes. The increase in traffic from proposed approved projects should be compared to the increase in traffic by applying an annual growth rate. This information should be provided by the Director.

If modeling information is unavailable, the greatest traffic increase from either the approved developments, the application of an annual growth rate, or a combination of an annual growth rate and approved developments, should be used to forecast the future traffic volumes. It is up to the discretion of the Director to select the appropriate methodology from information provided for all methods from the applicant.

- (ix) **Analysis Scenarios** – To determine the potential traffic impacts of a proposed development the following scenarios shall be analyzed in the TIA when appropriate:
- (A) Existing Conditions - Existing traffic operations based on recent traffic count data.
 - (B) Existing + Approved Conditions - Projected traffic operations reflecting changes to existing traffic volumes due to relevant approved developments. Approved development traffic is defined as traffic generated by all developments approved by local jurisdictions or submitted to local jurisdictions for approval within the development vicinity at the time of the TIA submittal.
 - (C) Existing + Approved Conditions + Project - This scenario is similar to scenario B with the addition of the proposed project traffic at study area intersections. If the development is expected to be completed beyond 12 months after the TIA is submitted, the Director may require an additional scenario of analysis, which would include regional growth on traffic beyond existing levels. This scenario would have an appropriate growth applied to existing traffic volumes to forecast the planning horizon (build-out) year.
 - (X) **Trip Generation** – To determine the impacts of a proposed development on the surrounding transportation network, the trip generation characteristics of that development must be estimated. Trip generation characteristics should be obtained from one of the following acceptable sources:
 - (A) Institute of Transportation Engineers (ITE) Trip Generation manual (latest edition).
 - (B) Specific trip generation studies that have been conducted for the particular land use for the purposes of estimating peak hour trip generating characteristics, subject to approval by the

Director prior to their inclusion in the transportation impact analysis.

In addition to new site generated trips, several land uses typically generate additional trips that are not added to the adjacent traffic network. These trips include pass-by, diverted and internal trips, and are considered to be separate from the total number of net new trips generated by the proposed development. The procedures listed in the ITE Trip Generation Handbook should be used where appropriate to account for pass-by, diverted and internal trips. The Traffic Engineer shall not use any pass-by, diverted or internal trip reductions without prior approval of the method or data sources by the Director.

(x) **Trip Distribution and Assignment** – Projected trips should be distributed and added to the projected non-site traffic on the roadways and intersections under study. The specific assumptions and data sources used in deriving trip distribution and assignment should be documented in the TIA and approved by the Director prior to submittal of the TIA. The site-generated traffic should be assigned to the street network in the study area based on the approved trip distribution percentages. Trip assignments should be rounded to the nearest five percent (5%). Graphic presentations as well as discussions in text of the trip assignment shall be documented in the TIA.

(xi) **Capacity Analysis** – An intersection capacity analysis is required as part of the TIA submittal. The software used for this analysis shall be the latest edition of the Highway Capacity Software (HCS), or a comparable software analysis program that is based on the Highway Capacity Manual methodology.

Peak hour Level-of-Service (LOS) must be calculated for each study intersection (existing and proposed). In most cases, the weekday morning (AM) and weekday evening (PM) peak hours must be included in the analysis. For certain types of development (e.g., recreation facilities, churches, some retail uses) some peak hours may be added (e.g., midday or weekends) or eliminated (e.g., AM peak hour for low traffic generators) from the analysis, if approved by the Director. Unless determined otherwise by the Director, compliance with the LOS standards will be based solely on weekday AM and PM peak hour traffic analysis results. For unsignalized intersections, appropriate MUTCD (Manual on Uniform Traffic Control Devices, FHWA) peak hour signal warrants must also be checked for each scenario.

The results of the above analysis shall be summarized in tabular form identifying the average delay, Level-of-Service (LOS), and volume-to-capacity (V/C) ratios for the study intersection. All intersections and specific turning movements with a LOS D or worse shall be clearly identified.

(xiii) **Queue Analysis** – Queue lengths shall be calculated for each lane of all approaches to signalized intersections for the 95th percentile queue during the peak hour of analysis. Queue lengths shall also be calculated for unsignalized locations, such as site driveways, where standing queues can interfere with other movements, especially if such interference can contribute to safety deficiencies. Appropriate analysis methods should be used that account for the actual arrivals of vehicles at an intersection. The methodology for queuing at unsignalized intersections or driveways must be approved by the Director prior to the TIA.

(xiv) **Left/Right Turn Storage Analysis** – Left-turn and right-turn storage bay analyses must be performed at all study intersections and project driveways identified in the traffic study scope. Storage at signalized intersections is to be calculated utilizing the Poisson method with 95% confidence and a 150 second wait. Storage at unsignalized intersections and driveways with either a dedicated left turn lane or a two-way-left-turn-lane is to be calculated utilizing the graphs found in the Washington State Department of Transportation's Design Manual.

For signalized intersections, queue lengths shall be based on average vehicle length of twenty-five (25) feet, or longer where appropriate.

(xv) **Traffic Simulation** – For a major development, a simulation using SimTraffic or other approved software should be done to show existing traffic flows and future traffic flows if directed by the Director.

(xvi) **Access and Site Circulation Analysis** – Describe the proposed access to the site for all travel modes. This includes identifying the existing and/or proposed access locations from the public street system and the expected use of such access (pedestrian/bicycle entrance, truck delivery access, etc.). Also describe any proposed roadways within the site and the internal street system configuration.

Summarize the sight distance evaluation conducted at the site accesses. Include the sight distance standards that need to be met and the measured available sight distance in both directions at each site driveway. The sight distance standard should be based on recent 85th percentile speed data conducted along the project frontage. Demonstrate that an adequate vision clearance triangle can be provided at each driveway. Provide the findings of the site access sight distance evaluation and any recommended improvements that may be needed.

Summarize the access spacing evaluation of the proposed site driveways. Provide the applicable City standards for each frontage roadway and site driveways. This analysis should be conducted for both existing and proposed site access locations.

Provide a detailed evaluation of the proposed site plan associated with on-site circulation needs for all modes of travel. This should include the following elements.

- Determine if the number of driveways can adequately and safely accommodate the peak hour vehicle demand.
- Evaluate driveway and cross street alignment and possible conflicts of movement.
- Evaluate the need for separate turn lanes to accommodate vehicles exiting the site and the potential for on-site vehicle queues to impact internal circulation.
- Review the internal roadway system to verify that emergency vehicles and trucks (potential demand based on land use) can be accommodated. Developments with a potential for generating large trucks should provide a turn template analysis of the site plan. The turn template analysis should be provided in the technical appendix.
- Identify how pedestrian and bicycle trips are accommodated between building entrances and parking lot areas. Internal pedestrian and bicycle circulation should be clearly demonstrated on the site plan. Discuss potential conflicts between pedestrians, bicycles and motor vehicles. Identify any land uses (if within one-half mile of site) that would likely generate pedestrian and bicycle trips in association with the proposed project. For example, a proposed subdivision located near a park, pedestrian and bicycle

connections to off-site destinations should be clearly demonstrated on the site plan. Discuss potential conflicts between pedestrians, bicycles and motor vehicles.

(xvii) Mitigation Requirements – For every significant impact the TIA must identify and discuss mitigation measures at conceptual level that will be implemented by the proposed development. The TIA may identify a mitigation measure or develop a range of mitigation measures for each impact to improve the performance of the transportation system. Mitigation measures shall be specific and feasible actions that will actually improve adverse transportation conditions, and shall comply with the City's design standards. The mitigation measures shall improve conditions or correct capacity deficiencies to acceptable levels of service. The TIA should discuss whether the measure reduces the impact to a less-than-significant level, and should report the conditions after the implementation of the mitigation measure.

An effective measure shall adequately avoid, minimize, rectify or compensate an impact. It shall be consistent with local plans and policies.

Mitigation measures may include traffic control devices and roadway design features. The Consultant shall determine the need for new traffic control devices, and roadway design features based on the City's traffic engineering policies and procedures. The installation of traffic control devices and construction of roadway design features shall conform to the City of Longview's standards and traffic engineering rules and regulations.

In addition, mitigation measures shall address vehicular queues, progression quality, and other factors that affect traffic conditions that are not part of the LOS analysis. They shall consider traffic operations at intersections and driveways.

b. Report Format – For consistency, the TIA report shall follow the outline described below. The Public Works Department and Community Development Department staff will review and comment on the TIA report.

- (i) The consultant shall also provide a CD which contains the following:
 - (A) A PDF version of the TIA
 - (B) A separate folder containing graphic files (i.e. JPG, BMP, TIFF format) of all graphics included in the TIA

(C) A separate folder containing the electronic files (i.e. SYNCHRO, HCS) for all analysis.

(D) A separate folder containing the electronic files for new traffic counts. The file format shall be .CSV. The count interval for both daily and peak counts shall be 15 minutes.

(ii) The consultant shall furnish three (3) copies of the TIA report stamped by the Traffic Engineer to the City. The following is the order and format for the TIA report.

1. EXECUTIVE SUMMARY
 - a. Purpose of Report and Study Objectives
 - b. Site Location and Study Area
 - c. Development Description
 - d. Principal Findings
 - e. Conclusions including mitigations
2. TABLE OF CONTENTS
3. LIST OF FIGURES
4. INTRODUCTION
 - a. Explanation of the project
 - b. Area map showing development site location
 - c. Complete project site plan, with buildings identified as to proposed use. Driveways located on adjacent property and across the street from the proposed project shall be shown on the site plan.
 - d. Project schedule, and stages or phases, if applicable
5. EXISTING CONDITIONS
 - a. Study Area
 - b. Existing Land Use Map. As a minimum, general land uses identified shall include residential, office/business, industrial, and retail.
 - c. Roadway System
 - d. Pedestrian/Bicycle Facilities
 - e. Transit
 - f. Sight Distance
 - g. Existing Land Use
6. EXISTING TRAFFIC DATA
 - a. Traffic Counts
 - b. Pedestrian Counts (if necessary)
 - c. Bicycle Counts (if necessary)
 - d. Times Collected
 - e. Locations

- f. Types - Daily, Morning, and Afternoon Peak Periods (two hours minimum, and others as required)
- g. Crash analysis
 1. Analysis Years
 2. Tabular Crash Report containing the following information:
 - a. Types of Crashes
 - b. Severity (Fatal, Injury, Property Damage Only)
 - c. Vehicular direction of travel
 - d. Time of Day
 - e. Day of Week
 3. Crash diagrams
7. EXISTING TRAFFIC OPERATIONS
 - a. Level of Service - Morning Peak Hour, Evening Peak Hour (and other as required)
 - b. Traffic Signal Warrant Analysis
 - c. Queue Analysis
8. TRIP GENERATION
 - a. Trip Generation
 - b. Pass-by Traffic (if applicable)
9. TRIP DISTRIBUTION AND ASSIGNMENT
 - a. Trip Distribution
 - b. Trip Assignment
10. EXISTING TRAFFIC OPERATIONS + APPROVED CONDITIONS + PROPOSED PROJECT
 - a. Level of Service - Morning Peak Hour, Evening Peak Hour (and other as required)
 - b. Traffic Signal Warrant Analysis
 - c. Queue Analysis
 - d. Left/Right-Turn Storage Analysis
 - e. Traffic Simulation
11. ACCESS AND SITE CIRCULATION ANALYSIS
 - a. Site access
 - b. Site access sight distance
 - c. Access spacing
 - d. Internal site circulation
12. SUGGESTED TRAFFIC MITIGATIONS

- a. Traffic Control Needs
 - b. Intersection Channelization Mitigation
 - c. Pedestrian/Bicycle Considerations
 - d. Neighborhood Traffic Mitigation
14. CONCLUSION AND RECOMMENDATIONS
15. TECHNICAL APPENDIX
- a. Traffic Volume Counts
 1. Average Daily 24 Hour Traffic Volumes
 2. Peak Hour Turning Movement Volumes (AM, PM and other as required)
 - b. Capacity Analysis Worksheets
 1. Existing Condition
 2. Existing + Approved Conditions
 3. Future +Existing + Approved Conditions
 4. Future +Existing + Approved Conditions + Proposed Project
 - c. Traffic Signal Warrant Analysis
 - d. Accident Data and Summaries
 - e. Miscellaneous Addendum

M. Street Access Connection Permit

If the new development or change in use, will generate or create an increase of more than 10 Peak Hour Trips (as defined within the Institute of Transportation Engineers Trip Generation Manual¹), each application for a street access connection permit, whether accompanying an underlying land use application or not, shall include the following unless the Director has waived the requirement:

1. Transportation Impact Study – Per KEDM Section 1.04.J
2. Existing Conditions Plan – The applicant shall provide a map or plan illustrating the following conditions on both sides of all streets:
 - a. Existing driveways
 - b. Existing sidewalks
 - c. Surrounding off-site conditions
 - d. Street depictions with names of streets for identification
 - e. Existing roadway classifications
 - f. Three Year accident history

¹ Institute of Transportation Engineers Trip Generation Manual, 7th Edition, 2003.

If none of these cases apply, a TIA may still be necessary if the Director deems that special circumstances require analysis (e.g., existing traffic congestion, safety concerns, public controversy, etc.). Conversely if any of these cases apply, the Director may waive the requirement of a TIA or require less analysis than would be required for a full TIA, depending on the situation.

N. Project Acceptance and Closeout

Prior to acceptance of any and/all public improvements, the following shall be submitted to the Director for review and approval:

1. Final plat showing:
 - a. Plat layout
 - b. Right-of-way dimensions including all curves
 - c. Public easements
 - d. Public tracts
 - e. Required notes
2. As-built drawings: The drawings shall be mylar and be identical to the approved construction drawings with all inverts, rims, and any other necessary changes noted to their as-built status. The words "As-Built Drawing" shall appear as the last entry in the revision block along with the month, day and year the as-built drawing was prepared.
3. CD copy containing:
 - a. PDF version of the as-built drawings
 - b. DWG version of the as-built drawings.
4. Copy of a receipt from the finance department showing that all required engineering fees have been paid.

1.05 Professional Qualifications

Professionals in the technical fields of Civil Engineering, Electrical Engineering, Geotechnical Engineering, Landscape Architecture, Soils Engineering, Structural Engineering, and Surveying who prepare or are responsible for the process of obtaining required permits/approvals shall be currently licensed or registered in the State of Washington and qualified by both experience and educational background in the specific technical areas as warranted by the specific needs of the proposed development project.

1.06 Changes to these Engineering Standards

From time to time changes may be needed to add, delete, or modify the provisions of the KEDM. The Director may propose changes to the KEDM and upon approval of the City Council, they shall become effective and shall be incorporated into the existing provisions.

1.07 Design Modification Process

A. Submittal

Requests to modify City Standards shall be submitted in writing by the Applicant Engineer to the Director. This written request shall state the desired modification(s), the reason(s) for the request(s) and a comparison between the specification(s), standard(s), and the modification(s).

Any request for modification or variance of City Standards should be documented with reference to nationally accepted specifications/standards.

B. Review

The request to modify shall be reviewed by the Director, who shall consult the appropriate review authorities and make one of the following decisions:

1. Approve as is,
2. Approve with changes, or
3. Deny with an explanation.

The modification, if approved, is for project specific use. Approval of a request shall not constitute a precedent.

C. Appeal

The applicant may appeal the Director's decision to the Hearing Examiner.

D. Criteria for Modification of Specification Standards

1. The Director may grant a modification to the adopted specifications or standards when any one of the following conditions are met:
 - a. The specification or standard does not apply in the particular application.
 - b. Topography, right-of-way, or other geographic conditions impose an unusual or unique hardship on the applicant and an equivalent alternative

which can accomplish the same design is available that does not compromise public safety or accessibility for the disabled.

- c. A change to a specification or standard is required to address a specific design or construction problem which if not enacted will result in an undue hardship or would jeopardize public safety.

1.08 Errors and Omissions

At the discretion of the City, any significant errors or omissions in the approved plans or information used as a basis for such approvals may constitute grounds for withdrawal of any approvals and/or stoppage of any or all of the permitted work. It shall be the responsibility of the applicant to show cause why such work should continue, and make such changes in plans that may be required by the City before the plans are re-approved.

1.09 Inspection

A. General Requirements

1. Work performed within the public right-of-way, or as described in the KEDM, whether by or for private applicant, by City forces, or by a City Contractor, shall be done to the satisfaction of the City and in accordance with the WSDOT Standard Specifications, any approved plans, and the KEDM. Unless otherwise approved, any revision to construction plans must be approved by the City before being implemented.
2. The City shall have authority to enforce the Standards as well as other referenced or pertinent specifications. The City will appoint project engineers, assistants, and inspectors as necessary to inspect the work and they will exercise such authority as the Director may delegate.
3. It is the responsibility of the applicant, Contractor, or their agents to have an approved set of plans, and/or permits on the job site wherever work is being accomplished.
4. It is the responsibility of the applicant, Contractor, or their agents to notify the City in advance of the commencement of any authorized work. A preconstruction conference and/or field review shall be required before the commencement of any work.
5. Failure to comply with the provisions of the KEDM may result in stop work orders, removal of work accomplished, or other penalties as established by ordinance.

B. Substitution of Materials

It is not the intent of the KEDM to exclude other equipment or materials of equal value, quality, or merit. Whenever a product is designated, or manufacturer's name, brand, or item designation is given or described, it shall be understood that the words "or approved equal" follows such name, designation, or description, whether in fact they do so or not. Determination of quality in reference to the project design requirement will be made by the Director. A Contractor shall not use an "equal" product without prior written approval of the Director.

C. City Inspector's Activities

Inspecting services provided by the City shall include:

1. Monitoring both work progress and performance testing results.
2. The performance of administrative and coordination activities, as required, to support the processing and completion of the project.
3. The issuance of a corrective notice to the Contractor to make corrections to the work. The City's project inspector, at the discretion of the Director, may post a stop work order.
4. Maintaining a completion file containing the following:
 - a. The original of the project completion certification.
 - b. A complete copy of the report file initiated by the City's project inspector.
 - c. The results of material tests, compaction tests, and soil analysis as detailed in the construction file.
5. Inform the Director of all proposed plan changes, material changes, corrective notices, stop work orders, or errors or omissions in the approved plans or specifications as soon as practical. Any revision to approved plans must be under the direction of the Applicant Engineer. It shall be at the discretion of the City's project inspector as to whether the revision is significant enough to warrant review by the Director. If so, the Applicant Engineer shall submit five (5) copies. No work affected by the revision shall be done until approved by the Director.

1.10 Contractor's Responsibility for Scheduling

A. Sequence of Operations

1. The Contractor shall plan construction work and execute operations with a minimum of interferences to the operation of the existing public facilities, including but not limited to, water, sewer, and roads. It may be necessary to do certain parts of the construction work outside normal working hours in order to avoid undesirable conditions, and it shall be the obligation of the Contractor to do this work at such times. This scheduling, however, is subject to the City's approval and does not relieve the Contractor from making work available for inspection.
2. The Contractor shall notify the City at least 48 hours (two full working days) prior to any City inspection. Connections between existing work and new work shall not be made until necessary inspection and tests have been completed on the new work and it is found to conform in all respects to the requirements of the plans and specifications.
3. Construction hours shall be seven (7) am to six (6) pm for all construction of all public improvements and within public right-of-way and seven (7) am to ten (10) pm for construction of private improvements outside of right-of-way, unless otherwise approved by the Director.

B. Step Inspections

1. The following items of work shall be inspected by City forces:
 - a. For street or sidewalk work, subgrade shall be inspected by the City (and tested by the Contractor) prior to placement of crushed surfacing.
 - b. Crushed surfacing shall be inspected by the City (and tested by the Contractor) prior to placement of paving, curb, or sidewalks.
 - c. Notify the City prior to the placement of any paving, curb, or sidewalks.
2. Other items of inspection notification are included under the various items of work outlined in the KEDM.

C. Progress of Construction

1. Construction shall proceed in a systematic manner that will result in a minimum of inconvenience to the public.
2. In the case of a pipe-laying job for sanitary sewer, storm drainage, and water improvements the trenching equipment at no time shall be greater than 100 feet ahead of the pipe-laying crew, unless given permission by the Director.

3. The trench shall be backfilled so that no section of the trench or pipe is left open longer than 24 hours. Trenches located in a right-of-way or public street shall be completely backfilled and cold patched, or securely placed before the Contractor leaves the site each day. All piping is to be plugged with a serviceable expansion plug at the end of each workday.

1.11 Contractor's Requirement for Testing

Testing shall be in accordance with the WSDOT Standard Specifications and performed by a certified independent testing lab hired by the applicant or applicant's contractor with the results being supplied to the Director. The applicant shall pay the cost of all testing.

The testing is not intended to relieve the Contractor from any liability for the trench restoration. It is intended to show the inspector and the City that the restoration meets these specifications. Testing shall include but not be limited to:

A. Asphalt Testing

Compaction of all lifts of asphalt as specified in the WSDOT Standard Specifications. Number of tests required:

1. For streets provide one (1) test per every 5,000 square feet of surface area.
2. For surface restoration of utility trenches provide one (1) test per every 200 feet of trench.

B. Subgrade and Crushed Surfacing Testing

Compaction testing as specified in the WSDOT Standard Specifications. Number of tests required:

1. For streets provide one test of the subgrade and one test of the crushed surfacing for every 5,000 square feet of surface area of pavement, curb, and sidewalk.

C. Bedding and Backfill for Utility Trenches

Compaction testing as specified in the WSDOT Standard Specifications. Number of tests required:

1. For utility trenches provide one test at top of bedding for every 500 feet of trench.
2. For utility trenches provide one test for each lift of backfill for every 500 feet of trench.

D. Embankment for Subgrade

Compaction testing as specified in the WSDOT Standard Specification. Number of tests required:

1. For each location where the fill is deeper than two (2) feet or greater than 300 cubic yards, provide one test per every two (2) vertical feet and every 500 cubic yards.

1.12 Safety Requirements

The Contractor is responsible for observing the safety of the work and all persons and property coming into contact with the work. The Contractor shall conduct his/her work in such a manner as to comply with all the requirements prescribed by the Occupational Safety and Health Administration (OSHA).

The City project inspector's role is not one of supervision or safety management, but is one of observation only. Nothing contained in this section or elsewhere in the book shall be interpreted to obligate the City to act in any situation, nor shift the Owner's responsibility for safety compliance to the City. No responsibility for the safety of the work or for construction means, methods, techniques, sequences, or procedures shall attach to the City by virtue of its action or inaction under this section.

1.13 Preservation, Restoration, and Cleanup

A. Site Preservation, Restoration, and Cleanup

1. During construction, the Contractor shall at a minimum flag areas of the site that have been designated for LID BMPs, including those areas to be preserved for dispersion, native vegetation retention, bio-retention, rain garden, and permeable pavements.
2. The Contractor shall keep the premises clean and orderly at all times during the work and leave the project free of rubbish or excess materials of any kind upon completion of the work. During construction, the Contractor shall stockpile excavated materials so as to do the least damage to adjacent lawns, grassed areas, gardens, shrubbery, trees, or fences, regardless of the ownership of these areas. All excavated materials shall be removed from these areas, and these surfaces shall be left in a condition equivalent to their original condition and free from all rocks, gravel, boulders, or other foreign material. Stockpiling of construction materials shall not be allowed on existing public rights-of-way.
3. All existing storm systems adjacent to the project area shall be cleaned and flushed with a water truck and/or sewer jetter, and original damage restored. Sediment, rock, and other debris shall be collected and disposed of in a proper manner. In no case shall debris be flushed down a storm or sanitary sewer for

disposal. All damaged/impaired storm facilities, irrigation, and house drainage pipes, drain tiles, sewer laterals, and culverts shall be repaired expeditiously.

4. All areas disturbed by the Contractor's operations inside dedicated rights-of-way or easements shall be restored to original condition. Areas outside of the easements or rights-of-way which are disturbed by the Contractor's operations shall be restored to their original or better condition in a method acceptable to the property owner. The Contractor shall obtain a written release from such property owners for any claims of injury or property damage prior to final acceptance of the work by the City.
5. On sites meeting certain thresholds for stormwater management in KEDM Chapter 2 of the KEDM, all soils disturbed by the Contractor's operations shall be replaced or amended to meet the standards of BMP T3.13, Post-Construction Soil Quality and Depth, in accordance with the SWMM/WV.

B. Street Cleanup

The Contractor shall clean all spilled dirt, gravel, or other foreign material caused by the construction operations from all streets and roads at the conclusion of each day's operation. If any spilled material poses an erosion control threat, it shall be cleaned immediately. Cleaning shall be by grader and front-end loader, supplemented by power brushing, and hand labor, unless otherwise approved by the City. The Contractor shall follow the City's erosion control procedures.

As soon as practical after completion of all paving and gravel shoulder resurfacing, the Contractor shall remove all dirt, mud, rock, gravel, and other foreign material from the paved surface and storm drainage system.

C. Stream and Creek Crossings

The Contractor shall comply with all provisions of the permits required by the Washington State Departments of Fish and Wildlife, the U.S. Army Corps of Engineers, Washington State Department of Ecology, the Kelso Municipal Code, and all conditions placed on the applicant.

Prior to construction involving a present or future right-of-way is performed in any stream, the method of operation and the schedule of such work shall be approved in writing by the Director.

D. Protection of Property

The Contractor shall exercise all due care in protecting property along the route of the improvement. This protection shall include, but not be limited to, trees, yards, fences, drainage lines, mailboxes, driveways, shrubs, and lawns. If any of the above

has been disturbed, they shall be restored to as near their original condition as possible or replaced to the owners approval.

E. Use of Explosives

All use of explosives is to follow Washington State Law.

Surrounding property owners affected by blasting are to be notified in writing a minimum of 48 hours in advance of the use of explosives.

Use of explosives should be done to limit the effects on surrounding neighbors.

Use of explosives must be approved by the City.

1.14 Railroad Crossings

A. General

Crossings of railroad rights-of-way shall be done in a manner, which conforms with the requirements of the railroad having jurisdiction. If any bonds and/or certificates of insurance protection are required, they shall be furnished by the Contractor or Owner to the railroad company with the City as an additionally-named insured.

B. Permits or Easements

Crossing agreements, permits, and/or easements for such crossings will be obtained by the applicant and all the terms of such permits or easements shall be met by the Owner and Contractor. A copy of the agreement, permit and/or easement shall be provided to the Director prior to construction drawing approval.

1.15 Penalties

Failure to comply with the KEDM will be cause for withholding or withdrawing approval of plans or plats, forfeiture of bond, withholding Temporary and/or Final Certificate of Occupancy, and/or other penalties as provided by law.

Chapter 2
Storm Drainage, Grading,
and Erosion Control

City of Kelso
Engineering Design Manual
February 2011
Amended June 2017

Chapter 2
Storm Drainage, Grading, and Erosion Control
City of Kelso
Engineering Design Manual
February 2011
Amended June 2017

Table of Contents

Description	Page No.
2.00 Purpose.....	1
2.01 General.....	1
2.02 Applicability.....	3
2.03 Minimum Requirements for Development and Redevelopment.....	3
2.04 Exceptions and Variations to the Minimum Requirements.....	5
2.05 Preparation of Stormwater Site Plans.....	7
2.06 Setbacks.....	8
2.07 Infiltration.....	9
2.08 General Conveyance Requirements.....	9
2.09 Closed Conduit Systems.....	10
2.10 Open Conveyance.....	13
2.11 Private Drainage.....	14
2.12 Subsurface Drainage.....	14
2.13 Curb Drains and Performed Connections.....	14
2.14 Stormwater Facility Plannings.....	15
2.15 Construction Site Limitations.....	16
2.16 Tracts and Easements.....	16
2.17 Stormwater Performance Bond.....	17
2.18 Stormwater Maintenance Bond.....	18
2.19 As-Built Plans.....	19
2.20 Dedication of Facilities.....	19
2.21 Long-Term Operation and Maintenance.....	19
2.22 Enforcement.....	22

Tables

Table 2.1: Stormwater Facility Setbacks.....	8
--	---

CHAPTER 2 - STORM DRAINAGE, GRADING, AND EROSION CONTROL

2.00 Purpose

This chapter is intended to provide minimum standards for managing storm drainage and controlling erosion, and sedimentation with land-disturbing activities, including development, redevelopment, clearing, and grading.

- A. Minimum standards are established to:
1. Protect the public health, safety, and welfare by minimizing risk from flood events;
 2. Protect property and habitat from increased runoff caused by development;
 3. Allow efficient operation, repair, and maintenance of the storm drain system;
 4. Reduce discharge of pollutants to the storm drain system and protect water quality;
 5. Reduce impacts to hydrology of surface waters;
 6. Reduce the erosion of soils on active construction sites and cleared areas; and
 7. Limit the discharge of sediment-laden runoff from active construction sites and cleared areas.

B. The requirements of this chapter cannot provide for all situations. They are intended to assist but not to substitute for competent work by design professionals.

2.01 General

A. The KEDM is written to comply with the Department of Ecology's (Ecology's) Phase II Municipal Stormwater National Pollutant Discharge Elimination System (NPDES) Permit, which requires Kelso to adopt the 2012 Stormwater Management Manual for Western Washington, as Amended in December 2014 (SWMW12/14) or an equivalent.

B. This Chapter adopts the SWMMW12/14. The Chapter references and supplements the SWMMW12/14 and is meant to be used in conjunction with the SWMMW12/14. An online version of the SWMMW12/14 can be found at:

<http://www.ecy.wa.gov/programs/wq/stormwater/manual/2014/SWMMW12/14/W12014%20SWMW12/14.htm>

C. When portions of this chapter and the SWMMW12/14 conflict, this chapter shall apply. When provisions of this chapter conflict with other City of Kelso Code or state and federal requirements, the more stringent provisions apply.

D. This Chapter is intended to represent the minimum Standards for the design and construction of stormwater drainage facilities.

1. Compliance with these Standards does not relieve the designer of the responsibility to apply sound professional judgment to protect the health, safety, and welfare of the general public.
2. Special site conditions and environmental constraints may require a greater level of protection than would be required under these Standards.
3. Site or weather changes or other unforeseen conditions may require modification of a site's erosion and sediment control strategy.
4. The project must be designed (and may require modification) to ensure compliance with the conditions of any permits, codes and regulations, and these Standards.
5. The design of stormwater drainage and/or retention/detention systems will depend on their type and local site conditions.

E. Erosion and sediment control BMPs shall be implemented prior to initial soil disturbance and until final stabilization following project completion and removal of temporary controls.

F. The City may temporarily suspend project work or require additional or modified protection measures if it appears to the Director, based upon observed conditions, that the approved plan is insufficient to prevent environmental harm and that such suspension or additional measures will prevent or minimize the harm.

G. The City may require a construction project to be scheduled to minimize the potential for erosion or other environmental harm.

H. Clearing and grading activities for developments shall be permitted only if conducted pursuant to an approved site plan (e.g. subdivision approval) that establishes permitted areas of clearing, grading, cutting, and filling.

I. Clearing and grading shall be prohibited in critical or environmentally sensitive areas unless written variances are secured from all applicable agencies.

J. Preparation of submittals:

1. All plans, studies, calculations, and reports that require the practice of engineering as defined in RCW 18.43.020(5)(a) shall be prepared by or under

the direction of a professional civil engineer registered in the state of Washington. Such plans, studies, calculations, and reports shall be stamped, signed, and dated by the licensed civil engineer(s) responsible for preparation of the Stormwater Site Plans.

2. Unless otherwise specified in these Standards, soils reports shall be prepared by a professional soil scientist certified by the Soil Science Society of America (or equivalent national program) or other suitably trained persons working under the supervision of a professional engineer, geologist, hydrogeologist, or engineering geologist registered in the state of Washington.

3. Stormwater Site Plans shall be prepared in accordance with the SWMMWW Vol. I, Section 3.1, Stormwater Site Plans, Step-by-Step, as modified in Section 2.05 of the KEDM.

K. Construction and Industrial Stormwater NPDES Permits. Obtain Ecology's Construction or Industrial Stormwater General Permit files required by Ecology. See Ecology website: <http://www.ecy.wa.gov/programs/air/stormwater/index.html>.

L. Other State and Federal requirements that could impact stormwater programs are summarized in SWMMWW Vol. IV, Appendix IV-D.

2.02 Applicability

A. Development and redevelopment projects that meet the thresholds in the SWMMWW Vol. I, Section 2.4 shall:

1. Apply the Minimum Requirements (MRs) for stormwater management in accordance with the SWMMWW Vol. I, Section 2.5, and as modified in KEDM Section 2.03.

2. Be evaluated using the definitions in the SWMMWW Vol. I, Section 2.3.

3. Meet all the requirements of this Chapter.

B. All land-disturbing projects regardless of size shall comply with KEDM Sections 2.11, 2.12, 2.13, and 2.15.

2.03 Minimum Requirements for Development and Redevelopment

A. Instructions for complying with each MR are as follows:

1. Preparation of Stormwater Site Plans

• Consult SWMMWW Vol. I, Section 2.5.1 for requirements for Preparation of Stormwater Site Plans.

• Consult SWMMWW Vol. I, Section 3.1 for step-by-step requirements for preparing a Stormwater Site Plan, as modified in KEDM Section 2.05.

• Consult KEDM Chapter 1 for submittal requirements.

2. Construction Stormwater Pollution Prevention

• Consult SWMMWW Vol. I, Section 2.5.2 and Vol. II for requirements for Erosion Control and Construction Stormwater Pollution Prevention.

• Consult the KEDM Section 2.04.D for variations from MR 2.

3. Source Control of Pollution

• Consult SWMMWW Vol. I, Section 2.5.3 and Vol. IV for requirements for Source Control of Pollution.

4. Preservation of Natural Drainage Systems and Outfalls

• Consult SWMMWW Vol. I, Section 2.5.4 for requirements for Preservation of Natural Drainage Systems and Outfalls.

• Supplemental Guidelines for Outfall Protection shall apply.

5. On-site Stormwater Management

• Consult SWMMWW Vol. I, Section 2.5.5 for requirements for On-Site Stormwater Management.

• Also, consult SWMMWW Vol. III and V for design of on-site stormwater management facilities.

6. Runoff Treatment

• Consult SWMMWW Vol. I, Section 2.5.6 for requirements for Runoff Treatment.

• Consult Section 2.04.C of these Standards for additional requirements.

• Also, consult SWMMWW Vol. V for selection and design of runoff treatment facilities.

7. Flow Control

• Consult SWMMWW Vol. I, Section 2.5.7 for requirements for Flow Control.

• Consult KEDM Section 2.04.A and B for exemptions and variations from MR 7.

• Also, consult SWMMWW Vol. III for selection and design of flow control facilities.

8. Wetlands Protection
- Consult SWMMWW Vol. I, Section 2.5.8 for requirements for Wetlands Protection. Note that meeting the requirement of this Chapter does not substitute for compliance with the Critical Areas requirements of KMC Chapter 18.20.
9. Operation and Maintenance
- Consult SWMMWW Vol. I, Section 2.5.9 for requirements for Operation and Maintenance.
 - Consult KEDM, Section 2.20 for additional requirements for long-term operation and maintenance.
- B. Redevelopment projects must rectify any drainage problems upon replacement or refurbishment of the affected system. For example, projects that grind and resurface a parking lot, which sheets over a sidewalk shall divert or intercept that runoff to a drainage system or to landscaping.
- 2.04 Exemptions and Variations to the Minimum Requirements
- A. Development and redevelopment projects are exempt from MRs only as described in the SWMMWW Vol. I, Section 2.2 and in the following circumstances:
1. Minimum Requirement 7: Flow Control. Projects within the Consolidated Diking Improvement District #1 (CDID #1) and Consolidated Diking Improvement District #3 (CDID #3) boundaries and sites discharging to these boundaries via manmade conveyances are exempt from MR 7 if the discharge meets each restriction listed in SWMMWW Vol. I, Section 2.5.7.
 2. Regional Facilities. The requirements for on-site management and against the transfer of runoff from one basin to another may be waived by the Director in areas served by a regional stormwater control facility. Such a waiver must be conditioned on the following provisions:
 - a. Basin Planning. The alternative or regional approach must comply with the Basin Planning provisions of SWMMWW Vol. I, Appendix I-A.
 - b. Services Contracted. The developer shall provide the City a copy of an executed contract with the regional facility demonstrating full compliance with the applicable standards.
 - c. Conveyance System Capacity. The conveyance system transporting the stormwater from the development to the facility shall be sized to handle the additional runoff. The developer shall be required to demonstrate the adequacy of the conveyance system by an engineer registered in the State of Washington.

3. Natural Drainage Features. Restoration of flow to natural drainage features may be allowed as an alternative to traditional detention to solve significant, pre-existing (i.e. not otherwise caused by the project) flooding, stream stability, water quality or habitat problems as determined by the Director. The project shall also satisfy all conditions of SWMMWW Vol. I, Sections 2.5.7 and 2.5.8, be documented by a qualified engineer or wetlands biologist, and receive approval from all relevant regulatory authorities.

B. Flow Control Variations

Flow control facilities shall be designed in accordance with the SWMMWW Vol. III and the following requirements:

1. Tailwater. Pond outfalls shall be analyzed for the tailwater effect on discharge with a backwater analysis. Consideration must be given to the backwater effect of high surface elevations in the downstream conveyance system. High tailwater elevations may affect performance of the upstream facility and reduce live storage volumes.
 2. Fencing. Ponds shall be fenced in accordance with the SWMMWW Vol. III, Section 3.2.1, except as follows:
 - a. A pond in which less than 10% of the perimeter has a vertical drop of greater than 30" and the remaining interior side slope is not steeper than 3H:1V may provide guardrail over the vertical drop in lieu of fencing.
 - b. Where chain link fences is required, landscaping shall be installed as screening, unless not feasible.
 3. Access.
 - a. Access to flow control facilities shall be provided in accordance with the SWMMWW Vol. III, Section 3.2.1.
 - b. Access roads shall have a durable all-weather surface.
- C. Water Quality Variations
- Water quality facilities shall be designed in accordance with the SWMMWW Vol. V and the following requirements:
1. All inlets and manholes within shall be stamped "Dump No Pollutants – Outfall to Stream," or equivalent. Similar-themed markers or stenciling in addition to this minimum requirement are encouraged.
 2. Permanent markers or signs, such as those described in the SWMMWW Vol. III Ch. 3.2.1, shall be installed for significant aboveground facilities such as ponds, bioswales, pervious streets, bioretention, or developments that rely on numerous

- b. Step 6 – Prepare a Construction Stormwater Pollution Prevention Plan (Section 3.1.6) may be delayed at the applicant's option until the Pre-construction Conference; and
- c. Step 7 – Complete the Stormwater Site Plan (Section 3.1.7) shall be replaced with the following text:

The Stormwater Site Plan encompasses the entire submittal for stormwater and drainage review. Elements of the Stormwater Site Plan shall be submitted in accordance with Chapter 1 of the KEDM. The Stormwater Site Plan includes the following four separate documents:

1. Site Development Drawings
2. Drainage Design Report
3. Long-Term Stormwater Site Management Plan
4. Construction Stormwater Pollution Prevention Plan

Elements of the Long-Term Stormwater Site Management Plan include those items necessary to assure continued operation and maintenance of the site's stormwater management facilities. These elements are required as described in Sections 2.1.6 and 2.2.0 of the KEDM.

To complete the Stormwater Site Plan, prepare a either an Abbreviated Stormwater Site Plan or a Full Stormwater Site Plan in accordance with the specifications in Chapter 1 of the KEDM.

2.06 Setbacks

Setbacks for stormwater facilities and on-site stormwater management BMPs shall be according to Table 2.1 below:

Table 2.1: Stormwater Facility Setbacks

On-Site Infiltration BMP (serving $\leq 5,000\text{ sf}$)	Structure / Foundation	Sensitive Area	Property Line	Other
Site Dispersion BMP Device (e.g. dispersion trench)	10'	10'	10'	See applications, limitations, suggested setbacks, and infeasibility criteria for each BMP in SWMMWW Vol. V.
Large Infiltration Facility (serving $>5,000\text{ sf}$)	5'	10'	5'	See applications, limitations, suggested setbacks, and infeasibility criteria for each BMP in SWMMWW Vol. V.
	100' if building is downslope; 20' if building is upslope	20' (from buffer)	20'	See applications, limitations, suggested setbacks, and infeasibility criteria for each BMP in SWMMWW Vol. V. Section 3.3.7. If the facility is stormwater storage or permeable pavement, also see infeasibility criteria for each BMP in Vol. V.

dispersed LID BMPs. Signs should identify the feature(s), state the purpose and/or function, provide contact information (for public facilities), and give any advisory message that is key to its proper and continued performance, such as "Dump no debris or pollutants. For more information or to report littering, vandalism, or other problems, call 360-423-6590."

D. Construction Stormwater Pollution Prevention Variations

1. Underground utility projects shall comply with MR 2 and the following additional requirements:
 - a. Where feasible, no more than five hundred (500) feet of trench shall be opened at one time;
 - b. Excavated material shall be placed to minimize runoff into the trench and adjacent roadway consistent with safety and space considerations; and
 - c. Trench dewatering devices shall be managed as described in Element #10 in SWMMWW Vol. II.

2. Diking District Maintenance. Routine dike and channel maintenance activities performed by diking districts must comply with MR 2 but are exempt from the requirement to submit a Construction Stormwater Pollution Prevention Plan.

3. Erosion Control Signage

- a. Erosion control signage approved by the City shall be installed at each point of entry for a project prior to land disturbance and shall be removed no sooner than issuance of a Certificate of Occupancy. Erosion control signs can be obtained from the City prior to construction at no charge.

2.05 Preparation of Stormwater Site Plans

A. The applicant for a development or redevelopment project that triggers MR 1 shall prepare a Stormwater Site Plan.

B. The Stormwater Site Plan shall be prepared as follows:

1. Follow the instructions in the SWMMWW Vol. I, Section 3.1, except:
 - a. References to "Projects that apply only Minimum Requirements 1 through #5" shall mean and refer to the City's stormwater submittal type "Abbreviated Stormwater Site Plan," and references to "Projects that are subject to Minimum Requirements #1 through #9" shall mean and refer to the City's stormwater submittal type "Full Stormwater Site Plan", and

Detention Facility	Structure / Foundation	Sensitive Area	Property Line	Other
	20'	20' (from buffer)	20'	See suggested setbacks for each type of detention facility in SWMM/WW Vol. III.
Water Quality Facility (e.g. bioswale)	20'	10'	20'	See setbacks for runoff treatment facilities in SWMM/WW Vol. V, Section 4.3.1.

* Given setbacks to sensitive areas may be used when no specific setback is given in KMC 17.26.
 † Setback is from the dispersion device, not from the flowpath. Flowpath may not enter an adjacent property.

2.07 Infiltration
 A. Infiltration facilities must comply with Ecology's Underground Injection Control (UIC) program, the Washington Department of Health's (DOH's) Wellhead Protection Program and other regulatory protections.

2.08 General Conveyance Requirements
 A. Conveyance, collection, culvert, and bridge design shall accommodate the entire contributing drainage area projected under full build-out conditions and not adversely affect existing downstream conveyance elements and flow conditions.
 B. Natural drainage flow routes to streams and wetlands shall be maintained, and discharges from the site shall occur at the natural location(s) and elevation(s), to the maximum extent practicable. See MRS 4 and 6.
 C. Vegetated open-channel conveyance is preferred and should be used whenever feasible and reasonable.
 D. Outfalls shall enter creeks or drainage channels perpendicular to the channel or angled downstream. Outfalls shall use energy dissipation to prevent erosion of the existing bank and/or channel bottom during the 100-year design storm in accordance with MR 4 Supplemental Guidelines. Energy dissipation shall be designed in accordance with SWMM/WW Vol. V, Section 4.5.3, Outfall Systems.

E. Storm drain conveyance systems shall be installed in accordance with the Kelso Standard Plans (see Appendix A) and the current WSDOT Standard Plans and Specifications for Road, Bridge, and Municipal Construction, with the notations as provided in this Chapter.
 F. Discharge to a diking district facility requires the diking district's approval.
 G. Any standard engineering methodology may be used to design closed conduit and open conveyance systems.
 H. Closed conduit systems shall be designed in accordance with KEDM Section 2.09.

I. Open conveyance systems shall be designed in accordance with KEDM Section 2.10.

2.09 Closed Conduit Systems

- A. Design Requirements
1. The 25-year storm shall show flow-flowing conditions through the proposed and/or existing conveyance system.
 2. The 100-year storm may overtop the conveyance system, provided:
 - a. The additional flow shall not extend beyond one-half of the width of the outside lane of the traveled way and shall not exceed a 4-inch depth at the deepest point, and
 - b. Waters do not rise to elevations more than one foot below that of the lowest aboveground floor of buildings.
 3. Backwater. At the discretion of the Director, or for the conditions listed below, a backwater analysis shall be conducted to determine the hydraulic grade line to ensure a minimum of 1.0-foot freeboard between the water surface and the top of any manhole or catch basin for the 25-year storm:
 - a. Pipes with slopes less than 0.5 percent.
 - b. Pipes with velocities over 6.5 feet per second (fps) (for sub critical flow only).
 - c. Inlet and outlet pipes forming a sharp angle (45 degrees or greater) at junctions, and
 - d. Pipe inverts less than 3 feet deep when entering and leaving junctions.
 4. Detailed information on this procedure can be found in the WSDOT Hydraulics Manual (WSDOT 2017) or Section 7 of the Federal Highway Administration (FHWA) Hydraulic Engineering Circular (HEC) 22, "Urban Drainage Design Manual".
 5. Pipe. All storm pipes shall be constructed of smooth interior pipe including bell & spigot joints with gaskets and shall be subject to air testing.
 - a. Alternate Materials. Where required for strength, such as for shallow bury (less than 24 inches to top of pipe), Class S2 ductile iron pipe shall be used. Other pipe materials may be used if approved by the Director.
 - b. Location (Tracer) Wire. Non-conductive pipe shall be laid with warning tape and location wire.

5. When necessary to locate drains in easements or tracts, the storm drain shall be centered in the easement. However, drains may be offset due to site conditions.
 6. The invert elevation of all upstream pipes shall not be lower than the invert elevation of the downstream pipe.
- C. Manholes
1. Manholes shall be located at all changes in slope, alignment, pipe size, and at all pipe junctions with present or future storm drains.
 2. Manholes shall be spaced no greater than 300 feet apart.
 3. Standard manholes are required when rim to crown of pipe elevations exceed four feet, otherwise flat-top manholes shall be used.
 4. The manhole cover shall be stamped "STORM."
- D. Collection. Stormwater collection systems shall be designed by accepted engineering practices with the following notes:
1. Curb inlets shall be located in streets at the curb-line to receive stormwater and convey it to the main storm drain.
 2. Curb inlets shall be at the following locations, whichever is less, unless otherwise approved by the Director:
 - a. Less than 300 feet apart.
 - b. In the tangent section immediately in advance of the curb returns on the upstream side of the intersection;
 - c. At all street ends with a descending grade, and
 - d. At intermediate locations such that gutter flow does not exceed three 3 feet in width or 3 inches in depth.
 3. Catch Basin grates shall be stamped "Dump no Pollutants – Outfall to Stream," or equivalent.
 4. Catch basins shall have a sump at least 15 inches below the lowest invert to collect sediment and debris.
 5. Curb inlets shall be used with curb and gutter installations up to 8% in tangential grade. Combination curb inlets shall be used for steeper grades and at road "low points."

5. Size. The minimum pipe size within the public right-of-way shall be 12 inches unless otherwise approved by the City Engineer. Storm laterals from private drains to inlets may be 6 inches and shall have a cleanout installed at the property line.
 6. Velocity. All storm drains shall be on a grade which produces a mean velocity when flowing full of at least three fps, unless prohibited by site conditions. The Director may waive this minimum where existing drainage systems make it impractical to meet the standard.
 - a. If velocities exceed 15 fps during the 25-year storm, anchors shall be provided at bends and junctions.
 - b. Velocities in pipes other than HDPE and iron are limited to 30 fps.
 7. Slope. A uniform slope between structures is required for all installed conveyance pipes. The allowable tolerance for sags or bottles in a newly installed pipe shall be 0.5 inches. For slopes steeper than 20 percent, closed conduit systems shall be designed by accepted engineering practices.
 8. Minimum separations from storm drains to sewers and water lines shall be as required for sewers in the Kelso Standard Plans (see Appendix A), or as approved by the Director. Storm lines shall be laid higher than sanitary sewers where possible.
 9. Pipes over 8 inches in diameter that "daylight" to the surface shall have a protective grate installed that prohibits wildlife and children from entering the storm line. The grate shall be hinged or otherwise designed to allow for cleaning and to reduce accumulation of debris from behind the grate.
- B. Alignment and Cover
1. All changes in pipe direction, slope, size and junctions shall be made at a manhole or other City approved structure.
 2. Storm drain lines shall not be curved between structures unless approved by the Director.
 3. Unless otherwise approved by the Director, a minimum cover of 36 inches of cover is required above the top of the pipe to the top of the ground surface. There shall be a minimum of one 14-foot separation from the top of pipe to the bottom of the roadway section (e.g. laterals from catch basins).
 4. In areas of relatively flat terrain, the design engineer must show that sufficient depth is provided at the boundary of the development to drain the upstream basins.

2.10 Open Conveyance

- A. The 25-year storm shall show free-flowing conditions through the proposed and/or existing conveyance system. Culverts with contributing drainage areas greater than 200-acres shall be designed to pass the peak runoff from the 100-year design storm.
- B. The 100-year storm may flow at bank-full, provided:
 - 1. Runoff is contained within defined conveyance system elements;
 - 2. The hydraulic grade line does not exceed the elevation of the roadway subgrade, and;
 - 3. Waters do not rise to elevations more than one foot below that of the lowest aboveground floor of buildings and no portions of a building will be flooded.
- C. Culverts. Culverts shall be designed in accordance with the current WSDOT Hydraulics Manual. Fish passage culverts shall meet the design criteria specified in the Washington Department of Fish and Wildlife (WDFW) Design of Road Culverts for Fish Passage.
- D. Backwater. A backwater analysis (see the King County Surface Water Design Manual for an example) shall be performed if a flow restriction (such as a bridge or culvert) causes flow to rise above normal depth within a channel reach.
- E. Side Slopes. Channel side slopes shall not exceed 2:1. Depth, safety, and erosion concerns must be considered with slopes steeper than 3:1. All constructed channels shall be compacted to a minimum 95 percent compaction verified by a modified Proctor test (ASTM D1557/A-SHTO T189).
- F. Freeboard. Channels designed for 25-year storm flows of 10 cubic feet per second (cfs) or less shall have at least 0.5 feet of freeboard, and 1.0 feet for greater velocities.
- G. Lining and Armor. Open channels shall be designed to withstand channel erosion and not degrade water quality.
 - 1. Channels with peak velocities less than 5 fps shall be vegetated.
 - 2. Channels with velocities above 5 fps shall be sufficiently armored to the maximum water surface elevation.
 - 3. Channels must be stabilized against erosion at the completion of construction. This may require temporary erosion control practices until the design vegetation is established.

2.11 Private Drainage

- A. Drainage Accessibility. Subdivision lots which drain to the rear should be avoided; but if necessary to collect roof drains, footing drains, and surface run-off, the developer shall:
 - 1. Provide a recorded stormwater easement for the City inspection of the private system and/or a recorded stormwater easement for any crossing of private property to reach the approved point of discharge in favor of the upstream landowner.
 - 2. Design and install the system to meet the Uniform Plumbing Code requirements.
- B. Stormwater easement geometry shall be in accordance with KEDM Section 2.16.

2.12 Subsurface Drainage

Underdrains shall be provided at the following locations:

- A. For all existing springs and tile intercepted during construction.
- B. Where high ground water exists or when it is necessary to reduce the piezometric surface to an acceptable level to prevent land slippage or under-floor flooding of buildings.
- C. The drainage line installed shall begin at a cleanout and terminate at an approved point of discharge.

2.13 Curb Drains and Perforated Connections

- A. When downspouts and footing drains must be connected to the private or public storm sewer systems, perforated connections (SWMMWW Vol. III, Section 3.1.3) from the home to the property line or curb are required where feasible in accordance with MR 5.
- B. Drainage from residential roofs and footings may drain directly to a street via a curb drain under the following circumstances:
 - 1. If the project is subject to MR 3, MR 5 must be satisfied for roofs;
 - 2. Perforated connections are used and designed in accordance with the SWMMWW.
 - 3. It can be shown that gravity drainage is possible.
 - 4. The existing street is adequately crowned and its drainage system, including curb, gutter, and storm lines, is adequately sized to accept the additional flow.

- 2.15 Construction Site Limitations
- A. Historical and Archaeological Areas
1. Upon excavation when burial sites, buried camp areas, village sites, and other distinctive archaeological or historical items are uncovered, or other items suspected of being of historical or archaeological significance are encountered, the Contractor shall report the matter to the City and the state liaison officer. Construction operations shall be stopped until the appropriate authorities can examine the area and give clearance to proceed with the work.
 2. Under the National Historical Preservation Act (P.L. 89-665; 1966), state liaison officers shall be notified when historical or archaeological items are unearthed.
 3. The Washington Criminal Code prohibits disinterment of a corpse without permission of the appropriate authorities.

- B. Other Requirements
1. Construction noise shall be minimized by the use of proper engine mufflers, protective sound reducing enclosures, and other sound barriers. Construction activities producing excessive noise that cannot be reduced by mechanical means shall be restricted to locations where their sound impact is reduced to a minimum at the edge of the work area. All construction noise shall be in accordance with KMC 8.28.
 2. The construction shall be done in a manner to minimize the adverse effects on fish, habitat, and wildlife resources.
 3. The use of water from a stream or impoundment shall not result in altering the temperature of the water body enough to affect aquatic life.

- 2.16 Tracts and Easements
- A. Stormwater treatment and flow control facilities to be owned by the City shall be located in a City right-of-way or on a storm drainage tract dedicated to the City.
- B. Storm drainage conveyances (including watercourses), treatment facilities, flow control facilities, and those on-site stormwater management BMPs used to meet treatment and flow control requirements to be privately maintained shall be located on a drainage easement.

The drainage easement shall grant the City and its representatives the right of entry for the purposes of inspecting and of maintaining, repairing, or restoring BMPs that have not been properly operated and maintained by the property owner. The right shall include the right to charge the property owner for the cost of maintenance, repair, and restoration of BMPs. The right shall include the right to enter a property

5. Pressurized outfalls, e.g. sump pumps, shall not be allowed to plume into the street or where they cause standing pools in the gutter, a slip or a vector hazard.
 6. For residential redevelopment, historical installation of curb drains are evident in the immediate neighborhood.
 7. Perforated connections shall not act as a conduit to discharge groundwater or springs to the storm sewer system.
- C. Curb drains will be allowed for residential development and redevelopment as approved by the Director.
- D. Curb drains shall not be allowed for new commercial development. Commercial redevelopment may use curb drains as approved by the Director.

- 2.14 Stormwater Facility Plantings
- Vegated stormwater facilities shall be planted as described in this section.
- A. Bioretention BMPs and Rain Gardens within a City right-of-way shall:
1. Meet the planting plan requirements of KEDM Section 3.19 and;
 2. Be planted in accordance with KEDM Section 3.19.

- B. There are two options for planting Bioretention BMPs and Rain Gardens on private property or within a stormwater tract dedicated to the City.
1. Optional Schematic Rain Garden Planting Plan and Worksheet for Private Property.
 - a. The applicant may elect to use the Optional Schematic Rain Garden Planting Plan and Worksheet for Private Property to develop the planting plan.
 - b. Fill out the worksheet for each Rain Garden, and submit it with the Site Development Drawings (see KEDM Section 1.04.F).

2. 2012 LID Technical Guidance Manual for Puget Sound planting guidance.
- a. Develop a detailed planting plan in accordance with the 2012 LID Technical Guidance Manual for Puget Sound.
- b. Submit the planting plan with the Site Development Drawings (see KEDM Section 1.04.F).

- C. Detention ponds, biofiltration swales and other vegetated stormwater facilities not listed in paragraphs A or B, above, shall be planted in accordance with recommended planting specifications in the SWMMWW.

when the City has a reasonable basis to believe that a violation of this Chapter is occurring or has occurred and to enter when necessary for abatement of a public nuisance or correction of a violation of this Chapter.

- C. Stormwater tracts and drainage easements shall be placed on all plats and property deeds and recorded with the Cowlitz County Auditor, after approval by the City.
- D. A drainage easement shall not be used for any purpose which would interfere with the unrestricted use of the storm drain line. No structures that prevent access are permitted within tracts or easements. Fences crossing tracts shall provide gates of sufficient width to provide access for maintenance.
- E. Minimum widths for public easements and/or tracts shall be as follows:
 1. Storm lines up to twenty-four inches in diameter shall have a minimum easement width of fifteen feet.
 2. Storm lines twenty-four inches and greater in diameter shall have a minimum easement width of twenty feet plus the pipe diameter.
 3. Depths greater than seven feet to the invert shall require wider easements. A slope of one horizontal to one vertical (1:1) from the storm drain invert to the ground surface shall be used in determining easement width.
 4. Channels with sufficient width to cover the 100-year floodplain line, fifteen feet from the waterway centerline, or ten feet from the top of the recognized bank, whichever is greater. A fifteen-foot-wide access easement shall be provided on both sides of the channel for channel widths greater than fourteen feet at the top of the recognized channel.
 5. Where right-of-way (or an easement) is required for access, it shall be a minimum of 15' wide and the Tract (or easement) shall extend to an acceptable access location.

2.17

Stormwater Performance Bond

At the discretion of Community Development, the applicant seeking to build a stormwater facility may be required to furnish a stormwater facility performance bond, or equivalent guarantee in lieu of a bond in a form acceptable to the City, in an amount sufficient to cover all costs associated with the construction of the facility. This bond is to secure the installation and performance of the stormwater facilities identified in the approved Stormwater Site Plan. Performance shall include, when applicable, plant establishment, infiltration rate and/or facility drawdown times within parameters established in the design, and all workmanship and materials. The applicant shall be responsible for any costs incurred by the City to secure performance of the stormwater facilities that are in excess of the amount of the bond.

- A. Term of Performance Bond. The stormwater performance bond furnished pursuant to this section, or the unexpended or unobligated portion thereof, shall be released to the applicant within sixty (60) days of issuance of the final acceptance of the permanent stormwater facilities by the Community Development Department. A final inspection by Community Development is required before any performance bond will be released.
- B. Partial Release of Bond. Community Development shall have the sole discretion to adopt provisions for a partial pro-rata release of the performance bond on the completion of various stages or phases of development.
- C. Bond Estimation. The applicant shall be responsible for determining bond value and submitting the estimation to the Community Development for approval. If the Director disagrees with the applicant's estimate, the Director shall determine a reasonable estimate. The bond value for public and private facilities is to be 125 percent of the estimated cost for the City to construct the stormwater features and achieve final stabilization.

2.18 Stormwater Maintenance Bond

- A. Stormwater Maintenance Bond. The applicant seeking final acceptance of a stormwater treatment and/or flow control facility for public ownership shall be required to furnish a maintenance bond, or equivalent financial guarantee in a form acceptable to the City, in an amount sufficient to cover costs associated with maintenance or repair in the event the stormwater facility does not meet the maintenance standards of the manufacturer, the SWMM/VW, the KEDM, and/or the approved operation and maintenance plan. A finding of deficiency in facility condition shall be based on inspection. For vegetated facilities, a finding of deficiency shall be made if plant survival after two years is less than 90% of the approved design. This bond is to secure the maintenance and repair of the stormwater facilities identified in the approved stormwater site plan. The applicant shall be responsible for any costs incurred by the City to bring the facility up to maintenance into compliance with approved standards in the event such costs that are in excess of the amount of the bond.
- B. Term of Maintenance Bond. The stormwater maintenance bond furnished pursuant to this section, or the unexpended or unobligated portion thereof, shall be released to the applicant within ninety days of the City inspection conducted on or after two years after the City's final acceptance of the permanent stormwater facilities by the Community Development department.
- C. Bond Estimation. The applicant shall be responsible for submitting the estimation of bond value to community development for approval. If the director disagrees with the applicant's estimate, the director shall determine a reasonable estimate. The bond value for public facilities shall be ten percent of the cost to construct the facility.

B. Responsible Party. The owner shall be responsible for the proper operation and maintenance of the parcel's stormwater facilities and shall pass such responsibility to any successor owner, unless such responsibility is transferred to the City or to another governmental entity as per KEDM Sections 2.1.6 or 2.20.

C. Stormwater Improvement Restrictive Covenant. The applicant shall prepare a Stormwater Improvement Restrictive Covenant that runs with the land for the site (e.g. plat) and for each lot within a subdivision that contains stormwater facilities. Prior to final acceptance of the project, the applicant shall record the covenant(s) with the Cowlitz County Auditor. A sample of a Stormwater Improvement Restrictive Covenant is included in Appendix 2-C.

1. Each Stormwater Improvement Restrictive Covenant for the site shall, at a minimum, include the following:
 - a. Designate the responsible party permanently responsible for maintenance.
 - b. Pass the responsibility for such maintenance to successors in title.
 - c. Establish a Stormwater Operation and Maintenance Plan to ensure the continued effectiveness of the stormwater facilities. The specifications of the Operation and Maintenance Plan vary depending on the types of facilities used on the site, as described in KEDM Section 2.21.D.
 - d. Restrict the removal and alteration of stormwater and drainage facilities without approval from the City of Kelso.
 - e. Grant the City and its representatives the right of entry for the purposes of inspecting all stormwater BMPs and of maintaining, repairing, or restoring BMPs that have not been properly operated and maintained by the property owner. The right shall include the right to charge the property owner for the cost of maintenance, repair, and restoration of BMPs.
 2. Each Stormwater Improvement Restrictive Covenant for individual lots, if required, shall include the following:
 - a. Designate the responsible party permanently responsible for maintenance.
 - b. Pass the responsibility for such maintenance to successors in title.
 - c. Describe and illustrate the operation and maintenance of the on-site stormwater management BMPs as described in KEDM Section 2.21.D.
 - d. Restrict the removal and alteration of on-site stormwater and drainage facilities without approval from the City of Kelso.
- D. Stormwater Operation and Maintenance Plan**
1. Site Stormwater System Manual. The applicant shall prepare a Site Stormwater System Manual for treatment facilities (MR 6) and flow control facilities (MR

2.19 As-Built Plans

As-Built Plans. Applicants are required to submit as-built plans for all permanent stormwater treatment and/or flow control facilities meeting MR 6 or MR 7, including any on-site stormwater management BMPs that are used to meet treatment or flow control requirements, after final construction is completed. The plans must show the final design specifications for all stormwater management facilities, meet the criteria for as-built plans in KEDM Chapter 1, and be sealed by a registered professional engineer.

2.20 Dedication of Facilities

The City will accept a dedication of a stormwater facility, together with necessary easements and appurtenances, upon a determination and acceptance, as provided herein, except that dedications made during the subdivision platting process shall not be subject to the following process:

- A. Preliminary Determination by Community Development. Upon receipt by the City of an offer of dedication of a stormwater facility, the Director shall make a preliminary determination that the dedication of the facility is appropriate to protect the public health, safety and general welfare, and further the goals of the City's stormwater management program and/or associated watershed plans. Budgetary implications will be a component of the determination. Prior to making a determination, the Director will inspect the facility to determine whether it has been properly maintained and is in good repair, and may condition the recommendation of acceptance on completion of any necessary maintenance items. The Director will forward his/her determination to the City Council.
 - B. Acceptance by City Council. City Council may reject or accept the offer of dedication by adoption of a resolution. Upon acceptance, the owner shall record the document dedicating the stormwater facility with the Cowlitz County Auditor by and at the owner's sole expense.
 - C. Owner to Provide Documentation. The owner, at his or her sole expense, shall provide any document or information requested by the Director and/or the City Council in order for a decision to be reached on whether or not to accept the facility.
- 2.21 Long-Term Operation and Maintenance**
- A. Operation and Maintenance Required. All erosion controls and stormwater facilities (including, but not limited to, structural and operational BMPs, on-site stormwater management BMPs, treatment and flow control facilities, catch basins and other protective devices, necessary access routes, and appurtenances) shall be operated and maintained in accordance with the manufacturer's specifications, the SWMMWW, the KEDM, the approved Stormwater Site Plan, and the stormwater maintenance agreement and plan, as discussed below.

7). including any on-site stormwater management facilities (MR 5) used to help meet MR 6 or MR 7 requirements.

The manual shall be submitted on 8 1/2" x 11" paper.

The Site Stormwater System Manual shall be customized to the particular facilities used on the site and shall contain at the minimum:

- a. An illustrative drawing of all stormwater management facilities, on-site stormwater management BMPs, and conveyances on the site.
- b. A narrative description of each facility, what it does, and how it works using language suitable for a non-technical audience such as an owner or maintenance staff.
- c. An illustration of each facility.
- d. Maintenance tasks and frequencies meeting standards of the SWMM/VWV. Pages drawn from the Clark County Stormwater Manual 2015, Book 4, or the City of Olympia 2016 Drainage Design and Erosion Control Manual Appendix IV-J may be used to meet the requirements of items b through d.
- e. Sample inspection form/checklist for each facility.
- f. Sample maintenance activity log.
- g. A prominent notification that the site owner must make the Site Stormwater System Manual and inspection records available for inspection by the City.
- h. A prominent notification that the site owner is required to record inspection and maintenance activities and to submit to the City by January 31 documentation of inspections performed during the previous year.

2. Individual Lot Operation and Maintenance Instructions. The applicant shall prepare simplified operation and maintenance instructions for each on-site stormwater management BMP (MR 5) on an individual lot or commercial site.

The Individual Lot Operation and Maintenance Instructions shall be customized to the particular facilities used on the lot or site and shall contain at the minimum:

- a. An illustrative drawing of all on-site stormwater management BMPs and conveyances on the site.
- b. A narrative description and maintenance instructions for each BMP on the lot using language suitable for a non-technical audience. The City offers simplified maintenance instruction handouts, which may be used to meet this requirement.
- c. An illustration or design detail of each facility.

d. If fall dispersion is proposed, or if newly planted trees or retained trees were claimed as flow reduction credits, then include a map of trees and vegetation areas to be retained.

E. Maintenance Escrow Requirement

1. At the discretion of the Director, the property owner will be required to post a cash escrow, letter of credit, or other acceptable form of performance security in an amount that would cover costs associated with maintenance and repair in the event of stormwater facility failure, at least 10% of the project engineer's estimate to construct the facility, in the event the Director determines that such security is necessary to ensure the facility satisfies the maintenance and performance requirements identified in these Standards and the approved Operation and Maintenance Plan. This instrument is required to be posted prior to completion of construction and release of the Stormwater Performance Bond and remain in place for a minimum of five (5) years.

2. At the discretion of the Director, the stormwater performance bond may be extended in lieu of the maintenance escrow account.

F. Maintenance Records. The responsible party shall keep records of the BMP's installation and all subsequent maintenance and repairs, and shall retain the records for at least five (5) years. These records shall be made available to the City within 1 week of inspection or upon request by the City.

2.22 Enforcement

Enforcement shall be consistent with KMC 1.50.

A. Protection of Watercourses and Facilities. It shall be a criminal violation to break, block, damage, destroy, uncover, deface or tamper with any watercourse, stormwater facility, or erosion control system.

B. Public Nuisance Declared. In addition to other remedies, failure to install and/or maintain watercourses, stormwater facilities, or erosion controls as required in this Manual and applicable permits is declared to be a public nuisance, subject to abatement as provided by KMC 1.50.

C. Suspension of Work or Access

1. Access to the municipal stormwater drainage system may be suspended if such termination is needed to abate or reduce an illicit discharge.

2. Work shall be suspended for unpermitted clearing and grading, or for projects that fail to provide required runoff controls for land-disturbing activities. After the stop-work period, the Director may allow work on-site to resume, provided

that such work is necessary to ensure compliance with this Manual, permits, or an approved stormwater drainage plan or SWPPP.

3. Resumption of work or reinstatement of connection to the municipal stormwater drainage system, without the prior approval of the City, shall be subject to the civil and/or criminal penalties delineated in KMC 1.50.

D. Financial Liability. The property owner and all persons engaged in development or land-disturbing activity shall be liable, jointly and severally, for all costs incurred by the City in any public nuisance action taken hereunder, or on account of damage or threatened damage to City property or facilities or water bodies, or associated with remedial actions necessitated by the damage or failure to install and/or maintain required stormwater facilities. The City may assess the responsible parties for these costs which shall be a lien on the property, or prorated against the beneficial users of the property, and may be placed on the tax bill and collected as ordinary taxes by the City.

APPENDIX 2-A

STORM DRAINAGE STANDARD DETAILS

Appendix 2-A Contents

Stormwater Details

Storm Drain General Notes	SD/EC-000	Revision Date
Grate Transition Section	SD-010	JUNE 2017
Curb Inlet	SD-020	JUNE 2017
Block Inlet (Square)	SD-030	JUNE 2017
Rectangular Planter	SD-040	JUNE 2017
Rectangular Curb Extension Plan	SD-050 I/D	JUNE 2017
Rectangular Curb Extension Planing Pan	SD-060 I/D	JUNE 2017
Planter Wall	SD-070 I/D	JUNE 2017
Reinforced Concrete Structure	SD-080 I/D	JUNE 2017
Trench Drain to Retention Facility	SD-100 I/D	JUNE 2017
Inlet/Outlet for Curb Extensions	SD-110 I/D	JUNE 2017
Side Curb Cut	SD-120 I/D	JUNE 2017
Catch Basin Type 1	WSDOT B-5, 20-02	JUNE 2017
Catch Basin Type 1L	WSDOT B-5, 40-02	JUNE 2017
Combination Inlet	WSDOT B-5, 26-01	JUNE 2017
Rectangular Frame	WSDOT B-30, 16-02	JUNE 2017
Rectangular Vented Gate	WSDOT B-30, 36-02	JUNE 2017
Catch Basin Type 2	WSDOT B-10, 26-01	JUNE 2017
Manhole Type 1	WSDOT B-15, 26-01	JUNE 2017
Circular Frame (Ring) and Cover	WSDOT B-30, 76-03	JUNE 2017
Miscellaneous Details for Drainage Structures	WSDOT B-30, 96-02	JUNE 2017
Grate Inlet Type 2	WSDOT B-35, 46-00	JUNE 2017
Welded Gates for Grate Inlet	WSDOT B-40, 26-00	JUNE 2017
Pipe Zone Bonding and Backfill	WSDOT B-55, 26-01	JUNE 2017
Connection Details for Dissimilar Culvert Pipe	WSDOT B-60, 26-00	JUNE 2017
Beveled End Sections	WSDOT B-70, 26-00	JUNE 2017

Erosion Control Details

Erosion Control General Notes	SD/EC-000	Revision Date
Silt Fence	WSDOT I-30, 15-02	JUNE 2017
Wattles	WSDOT I-30, 30-01	JUNE 2017
Compost Sock	WSDOT I-30, 40-01	JUNE 2017
Storm Drain Inlet Protection	WSDOT I-40, 20-00	JUNE 2017
Check Dams	WSDOT I-50, 20-01	JUNE 2017
Erosion Control Blanket	WSDOT I-60, 10-01	JUNE 2017
Sediment Trap	WSDOT I-80, 10-02	JUNE 2017
Stabilized Construction Entrance	WSDOT I-80, 10-02	JUNE 2017

EROSION CONTROL GENERAL NOTES

1. ALL EROSION CONTROL DEVICES SHALL BE CONSTRUCTED IN ACCORDANCE WITH THE EROSION CONTROL PLAN AND EROSION CONTROL DETAILS AND IN PLACE PRIOR TO START OF ANY LAND DISTURBING ACTIVITY.
2. ALL EROSION PREVENTION AND CONTROL BMPs SHALL BE INSPECTED, MAINTAINED AND REPAIRED AS NEEDED THROUGHOUT CONSTRUCTION TO INSURE CONTINUED PERFORMANCE OF THEIR INTENDED FUNCTION.
3. PERFORM ALL ACTIONS NECESSARY TO PREVENT EROSION AND CONTROL SEDIMENT, INCLUDING DUST, FROM LEAVING THE CONSTRUCTION SITE.
4. AS CONSTRUCTION PROGRESSES AND SEASONAL CONDITIONS DICTATE, MORE EROSION AND SEDIMENT CONTROLS MAY BE REQUIRED TO ENSURE THAT SEDIMENT AND SEDIMENT-LADEN WATERS DO NOT ENTER THE DRAINAGE SYSTEM, ROADWAYS, OR SURFACE WATERS.
5. SITES THAT ARE REQUIRED TO HAVE A CERTIFIED EROSION AND SEDIMENT CONTROL LEAD SHALL KEEP A CURRENT INSPECTION LOG ONSITE THAT SHALL BE AVAILABLE FOR CITY REVIEW.

STORM DRAIN GENERAL NOTES

1. TRACER WIRE SHALL BE INSTALLED IN THE SAME ORIENTATION TO THE INSTALLED NON-CONDUCTIVE PIPE IN ONE CONTINUOUS STRAND. INSTALL A WARNING TAPE 12 TO 18 INCHES ABOVE THE INSTALLED PIPE. CONTINUITY TESTING OF TRACER WIRE IS REQUIRED.
2. INSTALLED PIPE SHALL BE CLEANED BY USE OF HIGH PRESSURE NOZZLE AND VACUUM TRUCK PRIOR TO VIDEOING OR TESTING.
3. VIDEO INSPECTION SHALL BE PERFORMED ON THE INSTALLED PIPE. VIDEO INSPECTION SHALL DEMONSTRATE NO DEFORMATION, MANUFACTURING OR INSTALLATION DEFECTS, OR ANY DEBRIS IN THE LINES, FOR APPROVAL AND ACCEPTANCE BY THE CITY.
4. PRESSURE TESTING IN ALL STORM MAIN LINES IS REQUIRED.
5. IF SUBGRADE CONDITIONS ARE SUBSTANDARD, FOUNDATION MATERIAL SHALL BE INSTALLED TO THE DEPTH AS DIRECTED BY THE CITY ENGINEER.

STORM DRAIN AND EROSION CONTROL NOTES

STANDARD PLAN: SD/EC-000 CITY ENGINEER APPROVAL: Michael Karstka, P.E.
 DATE: 6-1-2017

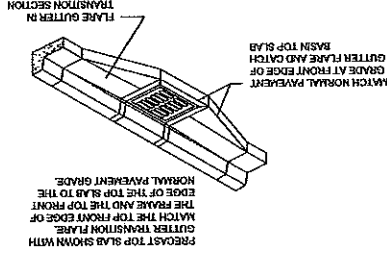
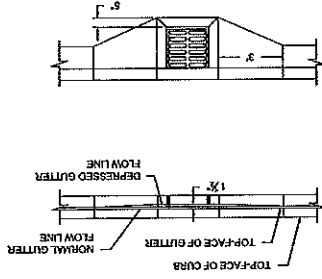

GUTTER TRANSITION SECTION

STANDARD PLAN: SD-010 CITY ENGINEER APPROVAL: Michael Karstka, P.E.
 DATE: 6-1-2017



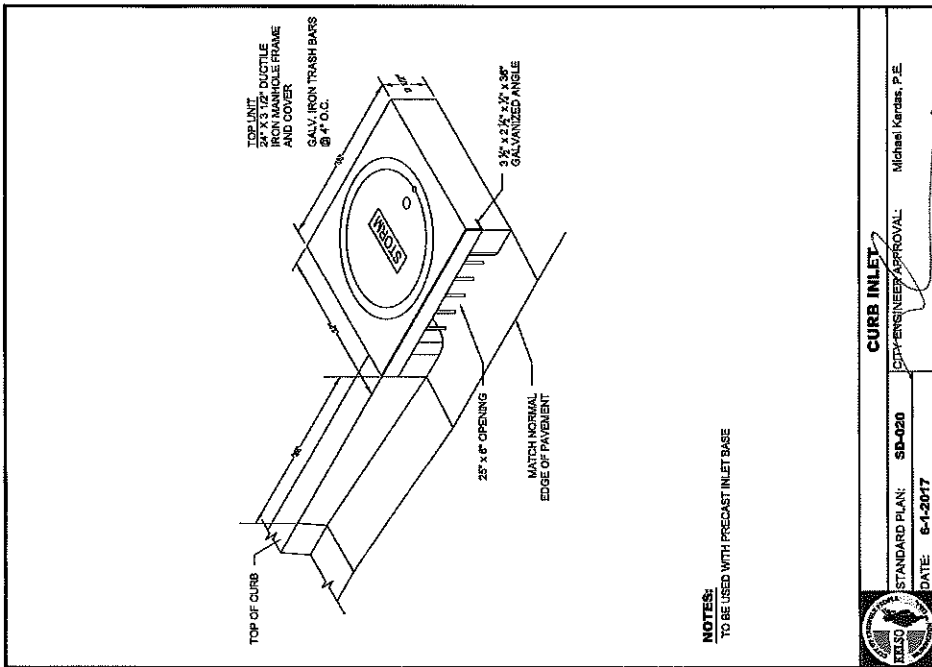

NOTES:
TO BE USED WITH PRECAST INLET BASE

CURB INLET

STANDARD PLAN: SB-020 CITY ENGINEER APPROVAL: Michael Karsten, P.E.

DATE: 6-1-2017

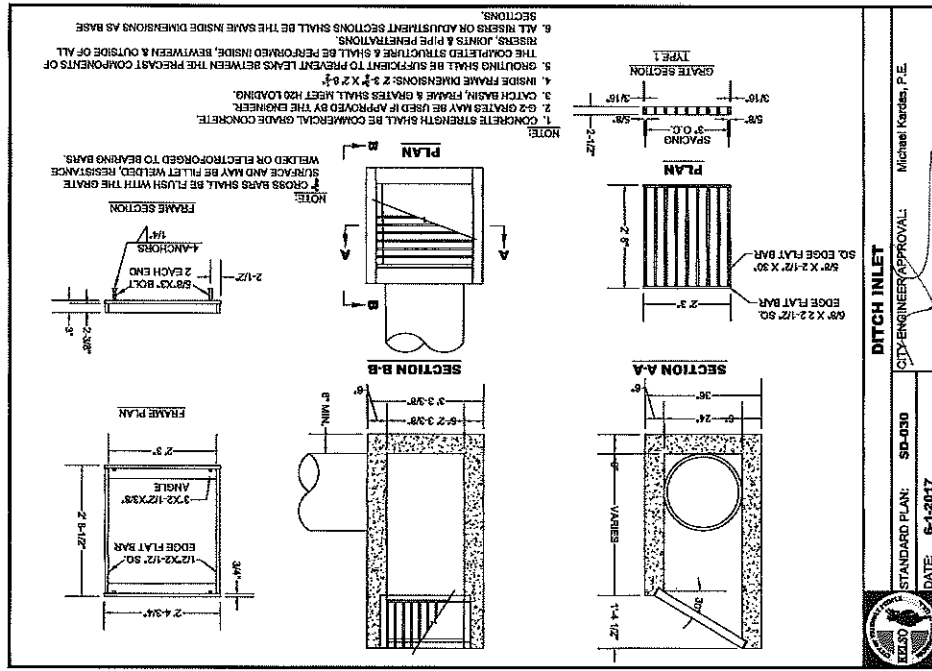

1. CONCRETE STRENGTH SHALL BE COMMERCIAL GRADE CONCRETE.
2. CATCH BASIN FRAME & GRATES SHALL MEET HD LADING.
3. CATCH BASIN FRAME & GRATES SHALL MEET HD LADING.
4. INSIDE FRAME DIMENSIONS: 2' 4" X 2' 4"
5. GROUTING SHALL BE SUFFICIENT TO PREVENT LEAKS BETWEEN THE PRECAST COMPONENTS OF RISERS, JOINTS & PIPE PENETRATIONS.
6. ALL RISERS ON ADJUSTMENT SECTIONS SHALL BE THE SAME INSIDE DIMENSIONS AS BASE SECTIONS.

NOTE:
CROSS BARS SHALL BE FLUSH WITH THE GRATE SURFACE AND MAY BE FULL FLT WELDED. RESISTANCE WELDED ON ELECTROFORCED TO BEARING BARS.

NOTE:
CROSS BARS SHALL BE FLUSH WITH THE GRATE SURFACE AND MAY BE FULL FLT WELDED. RESISTANCE WELDED ON ELECTROFORCED TO BEARING BARS.

DITCH INLET

STANDARD PLAN: SD-030 CITY ENGINEER APPROVAL: Michael Karsten, P.E.

DATE: 6-1-2017

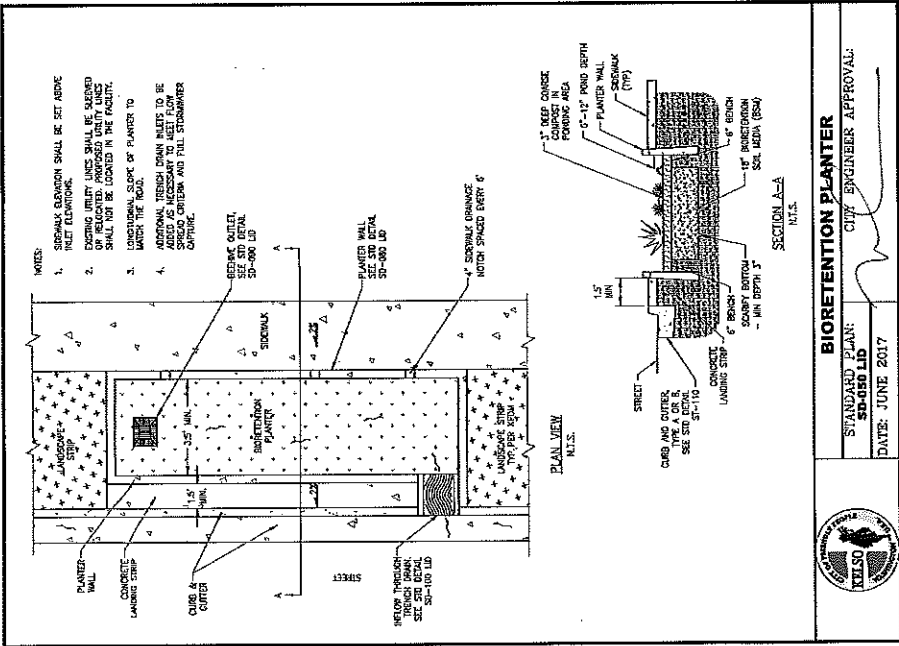

- NOTES:
1. SIDEWALK ELEVATION SHALL BE SET ABOVE INLET ELEVATIONS.
 2. EXISTING UTILITY LINES SHALL BE MARKED AND DEPTH SHALL NOT BE LOCATED IN THE FACILITY.
 3. MATCH THE SLOPE OF PLANTER TO EXISTING SIDEWALK.
 4. ADDITIONAL TRENCH DOWN INLETS TO BE ADDED AS NECESSARY TO AID FLOW INTO CURB AND FULL STORMWATER CAPTURE.

BIORETENTION PLANTER
 STANDARD PLAN:
 SD-030 LID
 DATE: JUNE 2017
 CITY ENGINEER APPROVAL:

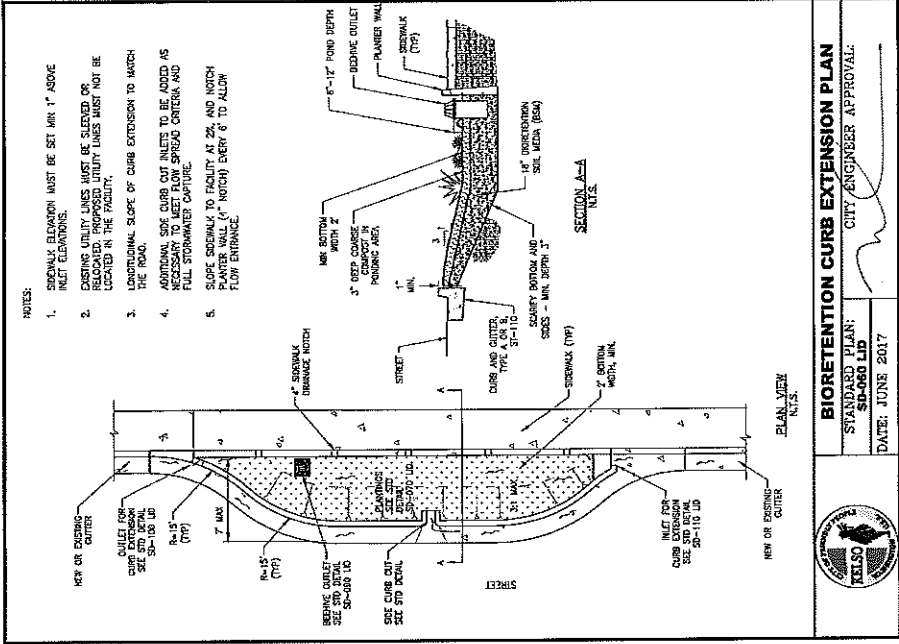

- NOTES:
1. SIDEWALK ELEVATION MUST BE SET MIN 1" ABOVE INLET ELEVATIONS.
 2. EXISTING UTILITY LINES MUST BE MARKED OR LOCATED IN THE FACILITY.
 3. SIDEWALK SLOPE OF CURB EXTENSION TO MATCH THE ROAD.
 4. ADDITIONAL SIDE CURB CUT INLETS TO BE ADDED AS NECESSARY TO AID FLOW INTO CURB AND FULL STORMWATER CAPTURE.
 5. SLOPE SIDEWALK TO FACILITY AT 2% AND NOTCH PLANTER WALL 1" NOTCH EVERY 6' TO ALLOW FLOW ENTRANCE.

BIORETENTION CURB EXTENSION PLAN
 STANDARD PLAN:
 SD-030 LID
 DATE: JUNE 2017
 CITY ENGINEER APPROVAL:



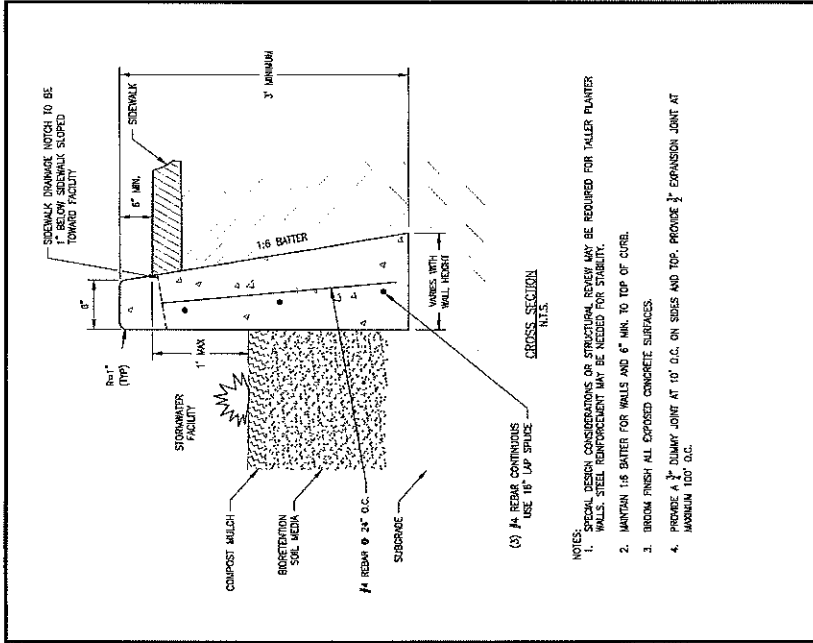

(3) #4 REBAR CONTINUOUS USE 10' LAP SPICE

- NOTES:
- SPECIAL DESIGN CONSIDERATIONS OR STRUCTURAL REVIEW MAY BE REQUIRED FOR TALLER PLANTER WALLS. STEEL REINFORCEMENT MAY BE NEEDED FOR STABILITY.
 - MAINTAIN 1:6 BATTER FOR WALLS AND 6" MIN. TO TOP OF CURB.
 - BRICKM FINISH ALL EXPOSED CONCRETE SURFACES.
 - PROVIDE A 3" DUMPFY JOINT AT 10' O.C. ON SIDES AND TOP. PROVIDE 3" EXPANSION JOINT AT MAXIMUM 100' O.C.

PLANTER WALL

STANDARD PLAN: SB-080 LID

DATE: JUNE 2017

CITY ENGINEER APPROVAL:

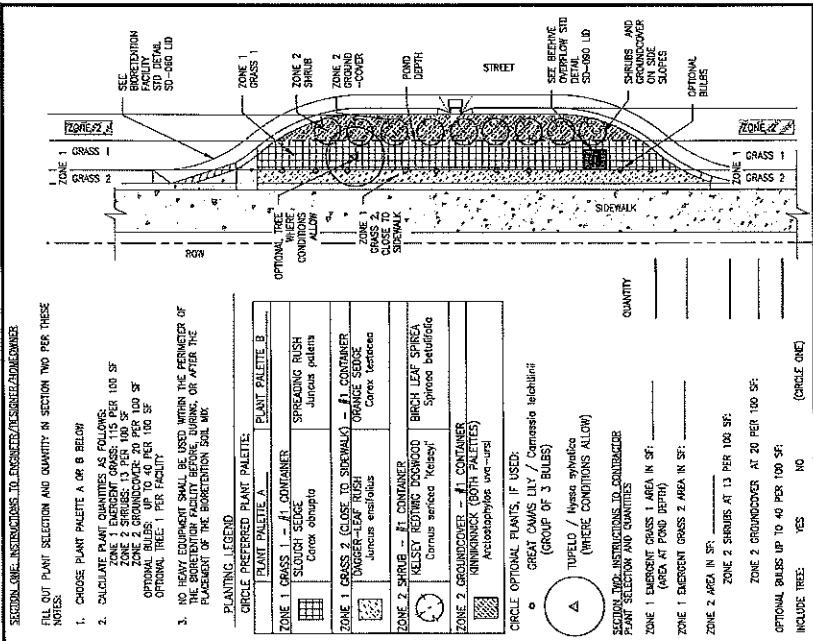

- SECTION ONE INSTRUCTIONS TO ENGINEER/OWNER:
- CHOOSE PLANT PALETTE A OR B BELOW
 - CALCULATE PLANT QUANTITIES AS FOLLOWS:
 ZONE 1 GRASS 1: 100 SF
 ZONE 2 GRASS 2: 13 PER 100 SF
 ZONE 2 SHRUBS: 20 PER 100 SF
 ZONE 2 GROUNDCOVER: 20 PER 100 SF
 OPTIONAL BULBS: UP TO 40 PER 100 SF
 OPTIONAL TREE: 1 PER FACILITY.
 - NO HEAVY EQUIPMENT SHALL BE USED WITHIN THE PERIMETER OF THE BIORETENTION FACILITY, UNLESS AFTER THE PLACEMENT OF THE BIORETENTION SOIL MIX.

PLANTING LEGEND

CIRCLE PREFERRED PLANT PALETTE	PLANT PALETTE A	PLANT PALETTE B
ZONE 1 GRASS 1	SPREADING RUSH Juncea peltata	SPREADING RUSH Juncea peltata
ZONE 2 GRASS 2	SLOUGH SEDGE Carex obtusata	SLOUGH SEDGE Carex obtusata
ZONE 2 SHRUB	SPREADING RUSH Juncea peltata	SPREADING RUSH Juncea peltata
ZONE 2 GROUNDCOVER	SPREADING RUSH Juncea peltata	SPREADING RUSH Juncea peltata

- CIRCLE OPTIONAL PLANTS, IF USED:
- GREAT CANVAS LILY / *Comastria litchii* (GROUP OF 3 BULBS)
 - TUPELO / *Nyssa sylvatica* (WHERE CONDITIONS ALLOW)
- SECTION TWO INSTRUCTIONS TO CONTRACTOR:
- PLANT SELECTION AND QUANTITIES
- ZONE 1 EMERGENT GRASS 1 AREA IN SF: _____
- ZONE 1 EMERGENT GRASS 2 AREA IN SF: _____
- ZONE 2 AREA IN SF: _____
- ZONE 2 SHRUBS AT 13 PER 100 SF: _____
- ZONE 2 GROUNDCOVER AT 20 PER 100 SF: _____
- OPTIONAL BULBS UP TO 40 PER 100 SF: _____
- INCLUDE TREE: YES / NO (CIRCLE ONE)

BIORETENTION CURB EXTENSION-PLANTING PLAN

STANDARD PLAN: SB-070 LID

DATE: JUNE 2017

CITY ENGINEER APPROVAL:



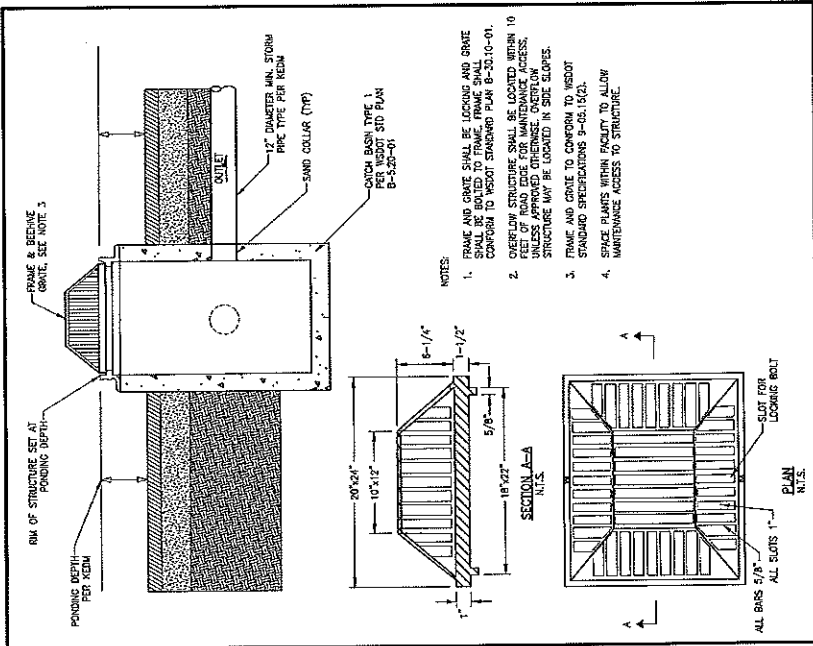

- NOTES:
1. FRAME AND GRATE SHALL BE LEGGING AND GRATE SHALL BE BOLTED TO FRAME. FRAME SHALL CONFORM TO WSDOT STANDARD PLAN 8-30.10-01.
 2. OVERFLOW STRUCTURE SHALL BE LOCATED WITHIN 10 FEET OF ROAD EDGE FOR MAINTENANCE ACCESS. UNLESS APPROVED OTHERWISE, OVERFLOW STRUCTURE MAY BE LOCATED IN SIDE SLOPES.
 3. FRAME AND GRATE TO CONFORM TO WSDOT STANDARD SPECIFICATIONS 9-05.15(2).
 4. SPACE PLANTS WITHIN FACILITY TO ALLOW MAINTENANCE ACCESS TO STRUCTURE.

BEEHIVE OUTLET STRUCTURE

STANDARD PLAN: SB-050 LD

DATE: JUNE 2017

CITY ENGINEER APPROVAL:

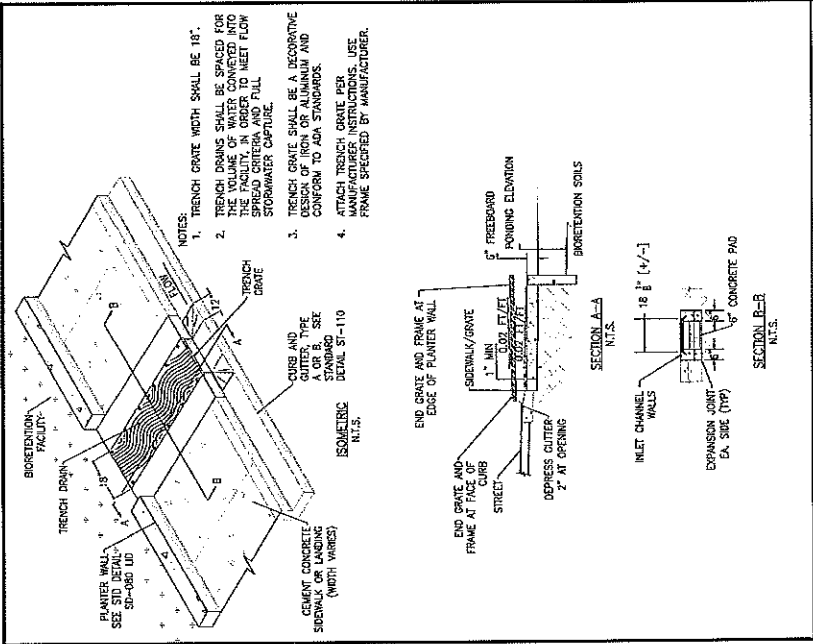

- NOTES:
1. TRENCH GRATE WIDTH SHALL BE 18".
 2. TRENCH DRAINS SHALL BE SPACED FOR THE VOLUME OF WATER CONVEYED INTO THE FACILITY, IN ORDER TO MEET FLOW CAPACITY AND TO PREVENT OVERFLOW STORAGE CAPTURE.
 3. TRENCH GRATE SHALL BE A DECORATIVE DESIGN OF THE FACILITY AND SHALL CONFORM TO ADA STANDARDS.
 4. ATTACH TRENCH GRATE PER MANUFACTURER'S INSTRUCTIONS. USE FRAME SPECIFIED BY MANUFACTURER.

TRENCH DRAIN TO BIORETENTION FACILITY

STANDARD PLAN: SB-100 LD

DATE: JUNE 2017

CITY ENGINEER APPROVAL:



DRAWN BY: LSA/CHD

PIPE ALLOWANCES	
PIPE MATERIAL	MAXIMUM OVERALL DEPTH (INCHES)
PRECAST CONCRETE	18"
ALUMINUM	24"
STEEL	30"
PRECAST CONCRETE (SPECIAL ORDER)	36"
STEEL (SPECIAL ORDER)	42"
PRECAST CONCRETE (SPECIAL ORDER)	48"
STEEL (SPECIAL ORDER)	54"

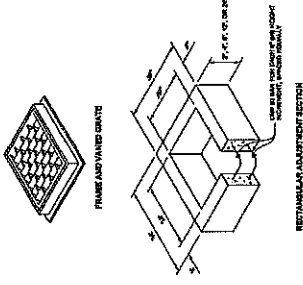

- NOTES**
- As acceptable alternatives to the other shown in the PRECAST BASE SECTION, Bases (shown according to the Standard Specifications), or other materials may be used with the catch basin cover shown in the ALTERNATIVE SECTION. The catch basin cover shall be placed in the PRECAST BASE SECTION. This means shall not be placed in the PRECAST BASE SECTION.
 - The finished ground level shall be greater than 20" (510 mm) above the top of the catch basin cover. The catch basin cover shall be placed in the PRECAST BASE SECTION. The catch basin cover shall be placed in the PRECAST BASE SECTION.
 - The maximum depth from the finished grade to the lowest pipe level shall be 18" (457 mm) for precast concrete, 24" (610 mm) for aluminum, 30" (762 mm) for steel, and 36" (914 mm) for precast concrete (special order) and 42" (1067 mm) for steel (special order).
 - The frame and grate shall be finished with the slope shown, if necessary, until the adjustment section with trench with.
 - The precast base section has been a rounded base, and the walls may be tapered at a rate of 1:24 or steeper.
 - The opening shall be measured at the top of the Precast Base Section.
 - All pickup holes shall be ground off after the base has been placed.

PIPE ALLOWANCES	
PIPE MATERIAL	MAXIMUM OVERALL DEPTH (INCHES)
PRECAST CONCRETE	18"
ALUMINUM	24"
STEEL	30"
PRECAST CONCRETE (SPECIAL ORDER)	36"
STEEL (SPECIAL ORDER)	42"
PRECAST CONCRETE (SPECIAL ORDER)	48"
STEEL (SPECIAL ORDER)	54"

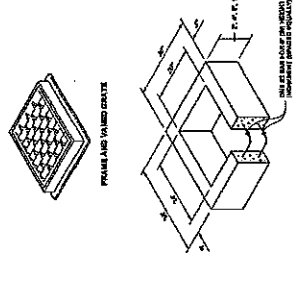

DRAWN BY: LSA/CHD

STATE OF MICHIGAN
DEPARTMENT OF TRANSPORTATION
STANDARD PLAN B-5-20-02
CATCH BASIN TYPE 1

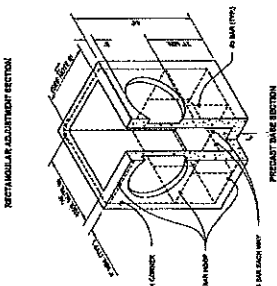
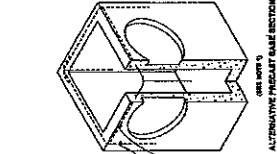

DRAWN BY: LSA/CHD

STATE OF MICHIGAN
DEPARTMENT OF TRANSPORTATION
STANDARD PLAN B-5-40-02
CATCH BASIN TYPE 4L



DRAWN BY: LSA/CHD

- NOTES**
- As acceptable alternatives to the other shown in the PRECAST BASE SECTION, Bases (shown according to the Standard Specifications), or other materials may be used with the catch basin cover shown in the ALTERNATIVE SECTION. The catch basin cover shall be placed in the PRECAST BASE SECTION. This means shall not be placed in the PRECAST BASE SECTION.
 - The finished ground level shall be greater than 20" (510 mm) above the top of the catch basin cover. The catch basin cover shall be placed in the PRECAST BASE SECTION. The catch basin cover shall be placed in the PRECAST BASE SECTION.
 - The maximum depth from the finished grade to the lowest pipe level shall be 18" (457 mm) for precast concrete, 24" (610 mm) for aluminum, 30" (762 mm) for steel, and 36" (914 mm) for precast concrete (special order) and 42" (1067 mm) for steel (special order).
 - The frame and grate shall be finished with the slope shown, if necessary, until the adjustment section with trench with.
 - The precast base section may have a rounded base, and the walls may be tapered at a rate of 1:24 or steeper.
 - The opening shall be measured at the top of the Precast Base Section.
 - All pickup holes shall be ground off after the base has been placed.

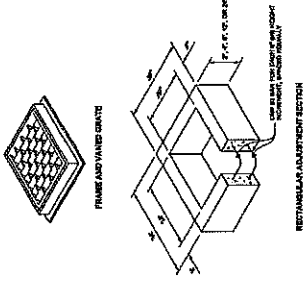

- NOTES**
- As acceptable alternatives to the other shown in the PRECAST BASE SECTION, Bases (shown according to the Standard Specifications), or other materials may be used with the catch basin cover shown in the ALTERNATIVE SECTION. The catch basin cover shall be placed in the PRECAST BASE SECTION. This means shall not be placed in the PRECAST BASE SECTION.
 - The finished ground level shall be greater than 20" (510 mm) above the top of the catch basin cover. The catch basin cover shall be placed in the PRECAST BASE SECTION. The catch basin cover shall be placed in the PRECAST BASE SECTION.
 - The maximum depth from the finished grade to the lowest pipe level shall be 18" (457 mm) for precast concrete, 24" (610 mm) for aluminum, 30" (762 mm) for steel, and 36" (914 mm) for precast concrete (special order) and 42" (1067 mm) for steel (special order).
 - The frame and grate shall be finished with the slope shown, if necessary, until the adjustment section with trench with.
 - The precast base section may have a rounded base, and the walls may be tapered at a rate of 1:24 or steeper.
 - The opening shall be measured at the top of the Precast Base Section.
 - All pickup holes shall be ground off after the base has been placed.

PIPE ALLOWANCES	
PIPE MATERIAL	MAXIMUM OVERALL DEPTH (INCHES)
PRECAST CONCRETE	18"
ALUMINUM	24"
STEEL	30"
PRECAST CONCRETE (SPECIAL ORDER)	36"
STEEL (SPECIAL ORDER)	42"
PRECAST CONCRETE (SPECIAL ORDER)	48"
STEEL (SPECIAL ORDER)	54"

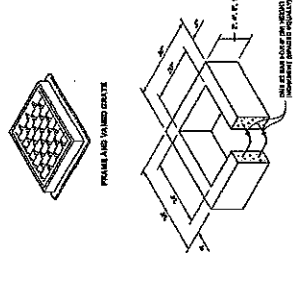

DRAWN BY: LSA/CHD

STATE OF MICHIGAN
DEPARTMENT OF TRANSPORTATION
STANDARD PLAN B-5-20-02
CATCH BASIN TYPE 1

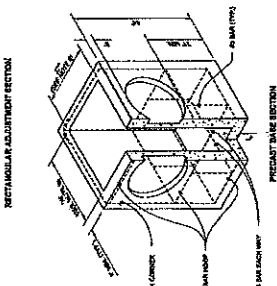
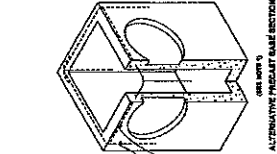

DRAWN BY: LSA/CHD

STATE OF MICHIGAN
DEPARTMENT OF TRANSPORTATION
STANDARD PLAN B-5-40-02
CATCH BASIN TYPE 4L



DRAWN BY: LSA/CHD

- NOTES**
1. All pipes are to be installed with a minimum slope of 1/8" per foot.
 2. The bottom of the present catch basin may be required to be replaced with a lighter weight concrete.
 3. The catch basin cover must be installed with the flange up and down.
 4. Catch basins shall have a maximum depth of 24" and a maximum width of 48". The maximum length between the second and third catch basin shall be 120'. The maximum length between the second and third catch basin shall be 120'. The maximum length between the second and third catch basin shall be 120'.

CATCH BASIN DIMENSIONS

CATCH BASIN SIZE (INCHES)	MIN. MAXIMUM DEPTH (INCHES)	MIN. MAXIMUM LENGTH (INCHES)	MIN. MAXIMUM WIDTH (INCHES)
48"	18"	120'	48"
36"	18"	120'	36"
24"	18"	120'	24"
18"	18"	120'	18"
12"	18"	120'	12"
6"	18"	120'	6"
3"	18"	120'	3"

PIPE ALLOWANCES

CATCH BASIN SIZE (INCHES)	MIN. MAXIMUM DEPTH (INCHES)	MIN. MAXIMUM LENGTH (INCHES)	MIN. MAXIMUM WIDTH (INCHES)
48"	18"	120'	48"
36"	18"	120'	36"
24"	18"	120'	24"
18"	18"	120'	18"
12"	18"	120'	12"
6"	18"	120'	6"
3"	18"	120'	3"



CATCH BASIN TYPE 2
 STANDARD PLAN B-1030-01
 APPROVED FOR CONSTRUCTION
 PROJECT NO. 12345
 DATE 01/01/2020
 PROFESSIONAL ENGINEER

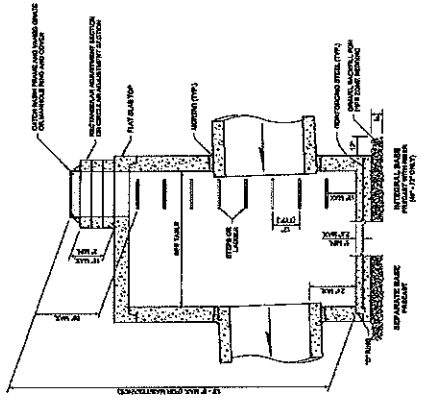

DESIGNED BY: [Name]

- NOTES**
1. All pipes are to be installed with a minimum slope of 1/8" per foot.
 2. The bottom of the present catch basin may be required to be replaced with a lighter weight concrete.
 3. The catch basin cover must be installed with the flange up and down.
 4. Catch basins shall have a maximum depth of 24" and a maximum width of 48". The maximum length between the second and third catch basin shall be 120'. The maximum length between the second and third catch basin shall be 120'.

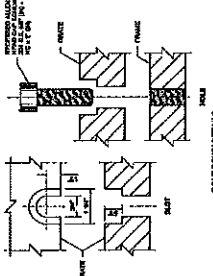

CATCH BASIN TYPE 2
 STANDARD PLAN B-1030-02
 APPROVED FOR CONSTRUCTION
 PROJECT NO. 12345
 DATE 01/01/2020
 PROFESSIONAL ENGINEER



SECTION A

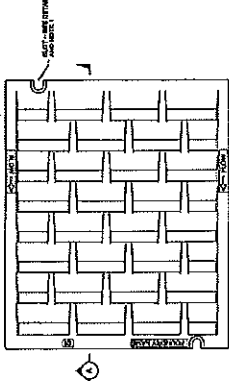

SECTION B

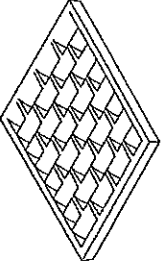

SECTION C

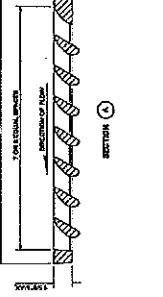

SECTION D

DESIGNED BY: [Name]

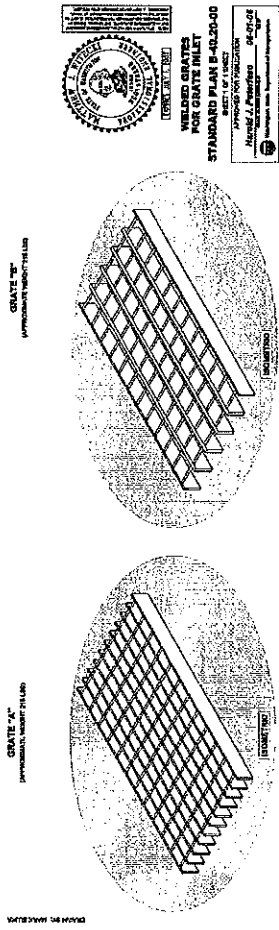
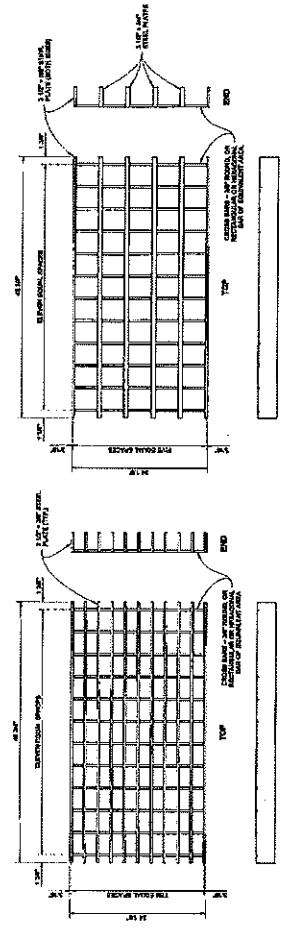

WELDED GRATES FOR GRATE INLET
STANDARD PLAN B-48-20-00
 DIVISION OF HIGHWAYS
 STATE OF MISSISSIPPI
 JACKSON, MISSISSIPPI
 DATE: 04-27-09
 PROJECT: MISSISSIPPI TURNPIKE
 CONTRACT: MISSISSIPPI TURNPIKE

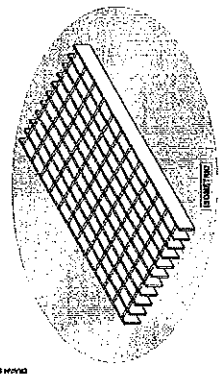
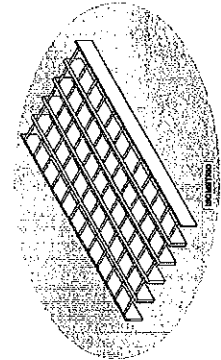

- NOTES**
1. The steel grates shall be set on bed with leveling bar of precast concrete grade. Steel frames shall be set on bed with leveling bar of precast concrete grade. Steel frames shall be set on bed with leveling bar of precast concrete grade.
 2. Top of steel grates shall be finished with 1/2" radius.
 3. All exposed concrete edges shall be finished with 1/2" radius.
 4. Pipes may enter through the grate on any side at any convenient depth, provided the outside of the grate shall be finished with 1/2" radius.
 5. The grate shall be finished with 1/2" radius on the top and bottom edges.
 6. The grate shall be finished with 1/2" radius on the top and bottom edges.
 7. Grates shall be finished with 1/2" radius on the top and bottom edges.
 8. All joints shall be finished with 1/2" radius on the top and bottom edges.
 9. See contract for type of grate supplied. See Standard Plan B-48-20 and B-48-20 for grate details.

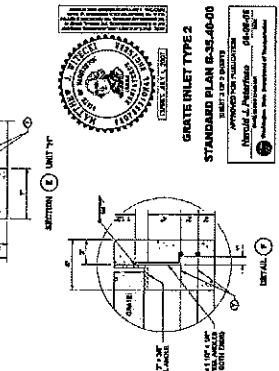

GRATE INLET TYPE 2
STANDARD PLAN B-48-40-00
 DIVISION OF HIGHWAYS
 STATE OF MISSISSIPPI
 JACKSON, MISSISSIPPI
 DATE: 04-27-09
 PROJECT: MISSISSIPPI TURNPIKE
 CONTRACT: MISSISSIPPI TURNPIKE

MARK	LOCATION	QTY	SIZE	LENGTH	DESCRIPTION
1	TOP WALL	2	12" x 12"	12'-0"	STRAIGHT
2	BOTTOM WALL AND SIDE WALL	2	12" x 12"	12'-0"	STRAIGHT
3	BOTTOM WALL AND SIDE WALL	2	12" x 12"	12'-0"	STRAIGHT
4	TOP WALL	2	12" x 12"	12'-0"	STRAIGHT
5	BOTTOM WALL AND SIDE WALL	2	12" x 12"	12'-0"	STRAIGHT
6	TOP WALL	2	12" x 12"	12'-0"	STRAIGHT
7	BOTTOM WALL AND SIDE WALL	2	12" x 12"	12'-0"	STRAIGHT
8	TOP WALL	2	12" x 12"	12'-0"	STRAIGHT
9	BOTTOM WALL AND SIDE WALL	2	12" x 12"	12'-0"	STRAIGHT
10	TOP WALL	2	12" x 12"	12'-0"	STRAIGHT
11	BOTTOM WALL AND SIDE WALL	2	12" x 12"	12'-0"	STRAIGHT

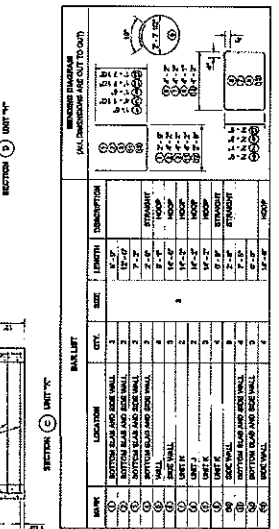
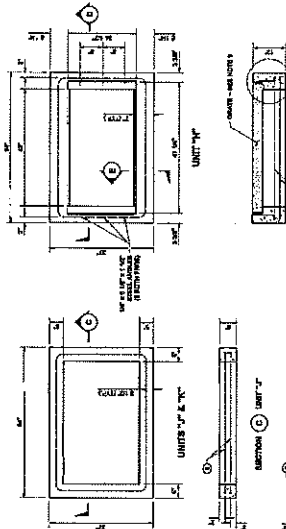

- NOTES**
1. The Concrete Collar shall be cast in one half of the inside pipe diameter of the largest pipe. The concrete collar shall be cast in one half of the inside pipe diameter of the largest pipe. The concrete collar shall be cast in one half of the inside pipe diameter of the largest pipe.
 2. See Manual (See Chapter 10) for FCS Collar and Standard Specifications 10.07. Inlet and Outlet shall be cast in one half of the inside pipe diameter of the largest pipe.
 3. When a Coupling Band connection is used, the collar shall be cast in one half of the inside pipe diameter of the largest pipe. The concrete collar shall be cast in one half of the inside pipe diameter of the largest pipe.
 4. The collar shall be cast in one half of the inside pipe diameter of the largest pipe. The concrete collar shall be cast in one half of the inside pipe diameter of the largest pipe.
 5. The collar shall be cast in one half of the inside pipe diameter of the largest pipe. The concrete collar shall be cast in one half of the inside pipe diameter of the largest pipe.

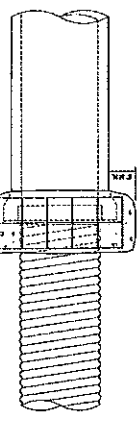

CONCRETE COLLAR OPTION

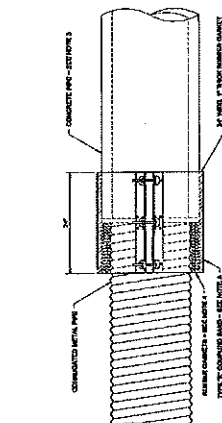

COUPLING BAND OPTION



CONNECTION DETAILS FOR
STANDARD PLAN B-3-20-00
APPROVED FOR INSTALLATION
Michael J. Rzesutsky, P.E.
Professional Engineer, State of Michigan
No. 100000

- NOTES**
1. See Standard Specifications Section 1-04.00 for Pipe Zone Bedding.
 2. See Standard Specifications Section 1-04.02 for Concrete Bedding for Pipe Zone Bedding.
 3. See Standard Specifications Section 1-04.03 for Concrete Bedding for Pipe Zone Bedding.
 4. For auxiliary sewer installation, concrete pipe shall be bedded in sand.

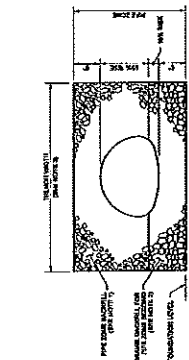

PIPE ARCHES



CONNECTION DETAILS FOR
STANDARD PLAN B-3-20-01
APPROVED FOR INSTALLATION
Michael J. Rzesutsky, P.E.
Professional Engineer, State of Michigan
No. 100000

PIPE	SIZE	MINIMUM CLEARANCE BETWEEN PIPE	MINIMUM CLEARANCE BETWEEN MANHOLE
CONCRETE	18" TO 30"	2"	2"
PIPE ARCH	18" TO 30"	2"	2"
METAL ONLY	18" TO 30"	2"	2"

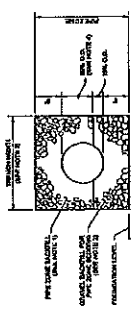

CONCRETE AND DUCTILE IRON PIPE

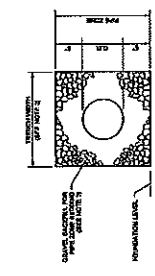

THERMOPLASTIC PIPE

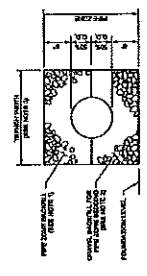

METAL AND STEEL RIB REINFORCED POLYETHYLENE PIPE

- NOTES**
1. The other ends shall be tapered to match the tapering of other ends of the pipe.
 2. The tapering shall be in accordance with the tapering of other ends of the pipe.
 3. The tapering shall be in accordance with the tapering of other ends of the pipe.
 4. The tapering shall be in accordance with the tapering of other ends of the pipe.



FOR COLUMNS OF DIAMETER OR LESS

REVEALED END SECTIONS

STANDARD PLAN E-10-00

APPROVED FOR PUBLICATION

March 1, 1950

U.S. DEPARTMENT OF COMMERCE

BUREAU OF STANDARDS

WASHINGTON, D. C.

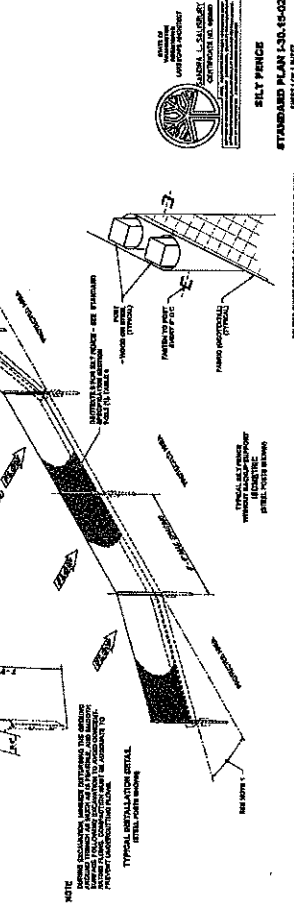

NOTE

1. The other ends shall be tapered to match the tapering of other ends of the pipe.
2. The tapering shall be in accordance with the tapering of other ends of the pipe.
3. The tapering shall be in accordance with the tapering of other ends of the pipe.
4. The tapering shall be in accordance with the tapering of other ends of the pipe.



FOR COLUMNS OF DIAMETER OR LESS

REVEALED END SECTIONS

STANDARD PLAN E-10-00

APPROVED FOR PUBLICATION

March 1, 1950

U.S. DEPARTMENT OF COMMERCE

BUREAU OF STANDARDS

WASHINGTON, D. C.



NOTE

1. The other ends shall be tapered to match the tapering of other ends of the pipe.
2. The tapering shall be in accordance with the tapering of other ends of the pipe.
3. The tapering shall be in accordance with the tapering of other ends of the pipe.
4. The tapering shall be in accordance with the tapering of other ends of the pipe.



FOR COLUMNS OF DIAMETER OR LESS

REVEALED END SECTIONS

STANDARD PLAN E-10-00

APPROVED FOR PUBLICATION

March 1, 1950

U.S. DEPARTMENT OF COMMERCE

BUREAU OF STANDARDS

WASHINGTON, D. C.

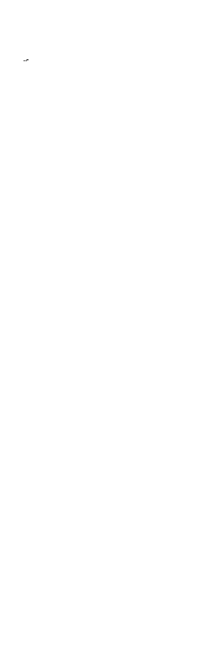

- NOTES**
1. Size the below-land Check Device (BCD) for the actual water collection it will receive.
 2. The BCD shall have a built-in high-flow relief system (overflow system).
 3. The overflow system must allow removal of the BCD without lifting the standard riser.
 4. Perform maintenance in accordance with Standard Specifications 9-2.2.10.

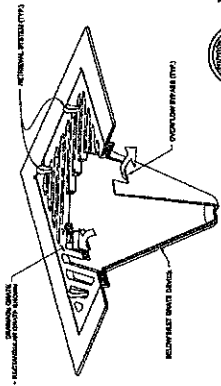
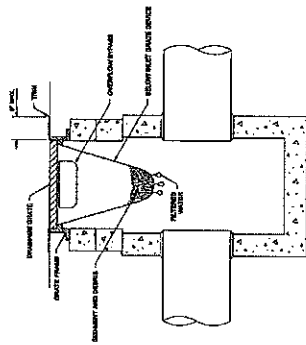

STATE OF TEXAS
 DEPARTMENT OF TRANSPORTATION
 TEXAS HIGHWAY DEPARTMENT

**STORM DRAIN
 INLET PROTECTION**

STANDARD PLAN 1-40-28-09

DESIGNED BY: J. M. MUSEL
 DATE: 08-28-07
 PROJECT: [REDACTED]



INDUSTRIAL VIEW

DRAIN PLAN 150-0700

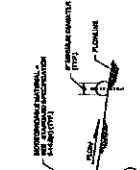
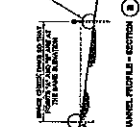
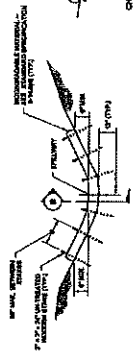

- GENERAL NOTES**
1. Check Dam shall meet the requirements of Standard Specifications 9-2.2.10 and 9-2.2.11.
 2. In channels, laid the slope type of the Check Dam is to be as shown on the drawing. The slope shall be as shown on the drawing.
 3. Perform maintenance in accordance with Standard Specifications 9-2.2.10.
 4. Perform maintenance in accordance with Standard Specifications 9-2.2.11.

NON-RIPPABLE CHECK DAM

1. Non-rippable Check Dam may meet minimum of 100% rating to prevent sediment or routing.

RIPPABLE CHECK DAM

1. Ripplable Check Dam shall meet minimum of 100% rating to prevent sediment or routing.

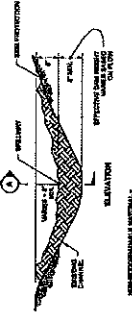

- NON-RIPPABLE CHECK DAM**
1. Non-rippable Check Dam shall meet minimum of 100% rating to prevent sediment or routing.
 2. Perform maintenance in accordance with Standard Specifications 9-2.2.10.
 3. To ensure adequate routing, Check Dam shall be placed in series with the next dam or structure in the channel.
 4. Check Dam shall be placed in series with the next dam or structure in the channel.
 5. To ensure adequate routing, Check Dam shall be placed in series with the next dam or structure in the channel.

EXTENDED SECTION



NON-RIPPABLE CHECK DAM

1. Non-rippable Check Dam may meet minimum of 100% rating to prevent sediment or routing.

STATE OF TEXAS
 DEPARTMENT OF TRANSPORTATION
 TEXAS HIGHWAY DEPARTMENT

**CHECK DAMS ON
 CHANNELS**

STANDARD PLAN 1-40-28-04

DESIGNED BY: J. M. MUSEL
 DATE: 08-28-07
 PROJECT: [REDACTED]



INDUSTRIAL VIEW

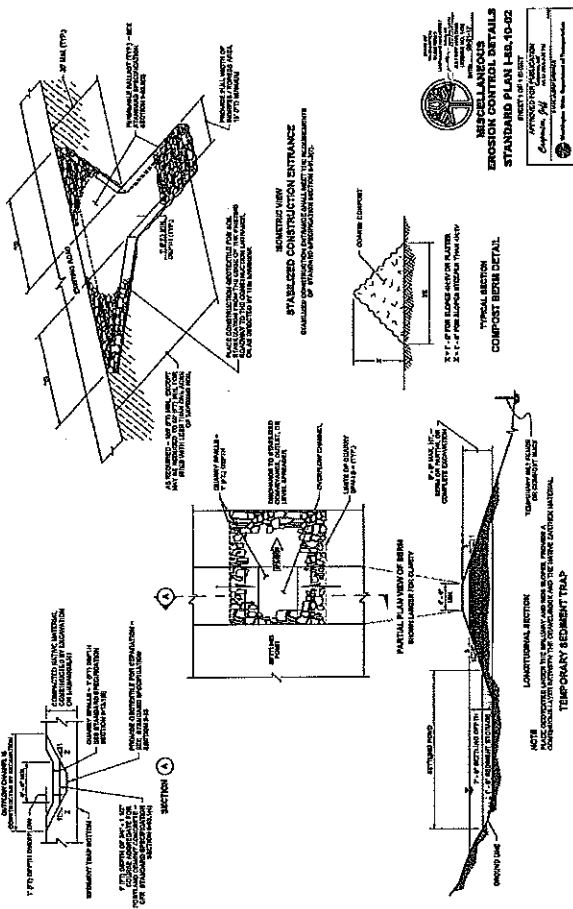

15000 1784 04 15000

MISCELLANEOUS STANDARD PLAN L.S. 10-62
 SHEET 1011-1
 PROJECT NO. 10-62
 DATE: 10/10/62
 DRAWN BY: J.M.
 CHECKED BY: J.M.
 APPROVED BY: J.M.
 PROJECT: [illegible]
 LOCATION: [illegible]

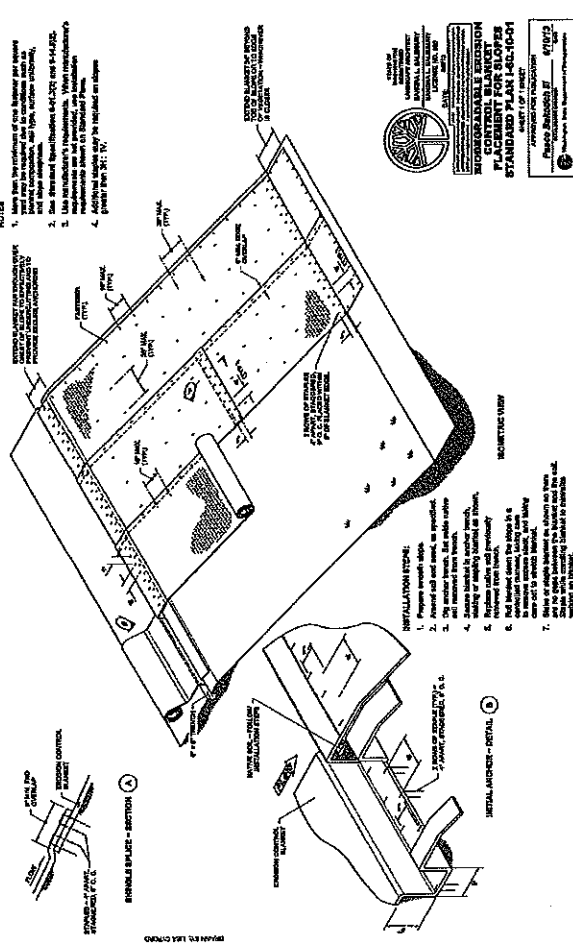

15000 1784 04 15000

MISCELLANEOUS STANDARD PLAN L.S. 10-62
 SHEET 1011-2
 PROJECT NO. 10-62
 DATE: 10/10/62
 DRAWN BY: J.M.
 CHECKED BY: J.M.
 APPROVED BY: J.M.
 PROJECT: [illegible]
 LOCATION: [illegible]

APPENDIX 2-B

Design Storm Data

Longview-Kelce Urban Area Rainfall Depth Relationships						
Storm Duration	Rainfall Depth, Inches					
	2-year	5-year	10-year	25-year	50-year	100-year
5-minute	0.14	0.20	0.23	0.28	0.32	0.36
10-minute	0.22	0.31	0.36	0.43	0.49	0.55
15-minute	0.28	0.39	0.45	0.54	0.62	0.70
30-minute	0.39	0.54	0.63	0.75	0.86	0.97
1-hour	0.50	0.68	0.80	0.95	1.09	1.23
2-hour	0.69	0.90	1.04	1.28	1.47	1.69
3-hour	0.87	1.11	1.27	1.59	1.82	2.12
6-hour	1.30	1.60	1.80	2.31	2.66	3.14
12-hour	1.92	2.35	2.70	3.34	3.91	4.65
24-hour	2.84	3.10	3.60	4.37	5.17	6.17

DESIGN STORM DATA

Longview-Kelso Urban Area						
Rainfall Depth, Inches						
Time	2-yr	5-yr	10-yr	25-yr	50-yr	100-yr
Minutes						
5	0.14	0.20	0.23	0.28	0.32	0.36
10	0.22	0.31	0.36	0.43	0.49	0.55
15	0.28	0.39	0.45	0.54	0.62	0.70
30	0.39	0.54	0.63	0.75	0.86	0.97
60	0.50	0.68	0.80	0.95	1.09	1.23
120	0.69	0.90	1.04	1.28	1.47	1.69
180	0.87	1.11	1.27	1.59	1.82	2.12
240	1.02	1.27	1.44	1.83	2.10	2.46
300	1.16	1.44	1.62	2.07	2.38	2.80
360	1.30	1.60	1.80	2.31	2.66	3.14
420	1.40	1.73	1.95	2.48	2.86	3.39
480	1.51	1.85	2.10	2.66	3.07	3.64
540	1.61	1.98	2.25	2.83	3.28	3.89
600	1.71	2.10	2.40	3.00	3.49	4.15
660	1.82	2.23	2.55	3.17	3.70	4.40
720	1.92	2.35	2.70	3.34	3.91	4.65
780	1.97	2.41	2.78	3.43	4.02	4.78
840	2.02	2.48	2.85	3.51	4.12	4.90
900	2.08	2.54	2.93	3.60	4.23	5.03
960	2.13	2.60	3.00	3.68	4.33	5.16
1020	2.18	2.66	3.08	3.77	4.44	5.28
1080	2.23	2.73	3.15	3.86	4.54	5.41
1140	2.28	2.79	3.23	3.94	4.65	5.54
1200	2.33	2.85	3.30	4.03	4.75	5.66
1260	2.39	2.91	3.38	4.11	4.86	5.79
1320	2.44	2.98	3.45	4.20	4.96	5.92
1380	2.49	3.04	3.53	4.28	5.07	6.04
1440	2.54	3.10	3.60	4.37	5.17	6.17

Longview-Kelso Urban Area						
Rainfall Intensity, Inches per Hour						
Time	2-yr	5-yr	10-yr	25-yr	50-yr	100-yr
Minutes						
5	1.73	2.37	2.78	3.31	3.80	4.27
10	1.35	1.84	2.15	2.56	2.94	3.31
15	1.14	1.55	1.82	2.17	2.49	2.80
30	0.79	1.07	1.26	1.50	1.72	1.94
60	0.50	0.68	0.80	0.95	1.09	1.23
120	0.35	0.45	0.52	0.64	0.73	0.84
180	0.29	0.37	0.42	0.53	0.61	0.71
240	0.25	0.32	0.36	0.46	0.53	0.61
300	0.23	0.29	0.32	0.41	0.48	0.56
360	0.22	0.27	0.30	0.39	0.44	0.52
420	0.20	0.25	0.28	0.35	0.41	0.48
480	0.19	0.23	0.26	0.33	0.38	0.46
540	0.18	0.22	0.25	0.31	0.36	0.43
600	0.17	0.21	0.24	0.30	0.35	0.41
660	0.17	0.20	0.23	0.29	0.34	0.40
720	0.16	0.20	0.23	0.28	0.33	0.39
780	0.15	0.19	0.21	0.26	0.31	0.37
840	0.14	0.18	0.20	0.25	0.29	0.35
900	0.14	0.17	0.20	0.24	0.28	0.34
960	0.13	0.16	0.19	0.23	0.27	0.32
1020	0.13	0.16	0.18	0.22	0.26	0.31
1080	0.12	0.15	0.18	0.21	0.25	0.30
1140	0.12	0.15	0.17	0.21	0.24	0.29
1200	0.12	0.14	0.17	0.20	0.24	0.28
1260	0.11	0.14	0.16	0.20	0.23	0.28
1320	0.11	0.14	0.16	0.19	0.23	0.27
1380	0.11	0.13	0.15	0.19	0.22	0.26
1440	0.11	0.13	0.15	0.18	0.22	0.26

APPENDIX 2-C

EXAMPLE STORMWATER IMPROVEMENT RESTRICTIVE COVENANT

When Recorded Return To:

WASHINGTON STATE COUNTY AUDITOR/RECORDERS
 INDEXING FORM (Cover Sheet)
 RCY 05/04

Please print or type information Document Title(s) (or, if multiple combined therein):
Reference Number(s) of Document assigned or released:
<input type="checkbox"/> Additional reference #'s on page _____ of document. Grantor(s) (Last name first, then first name and initials):
<input type="checkbox"/> Additional Grantor(s) on page _____ of document. Grantee(s) (Last name first, then first name and initials):
<input type="checkbox"/> Additional Grantee(s) on page _____ of document. Legal Description (abbreviated as to block, plat or section, township, range):
<input type="checkbox"/> Additional legal description on page _____ of document. Assessor's Property Tax Parcel/Account Number(s):
<input type="checkbox"/> Assessor Tax # not yet assigned. The Auditor/Recorder will rely on the information provided on this form. The Auditor/Recorder will not be deemed to verify the accuracy or completeness of the indexing information provided herein.

RECITALS

- A. Grantee is the regulatory agency responsible for managing stormwater within the City of Kelso.
- B. Grantor is the owner of certain real Property in the City of Kelso, Washington, described above and referred to in this Agreement as the "Property."
- C. Grantor desires to construct a development on said Property, which development is known as _____, in conjunction with this development, Grantor is constructing a storm collection, conveyance, treatment, flow control, and/or on-site stormwater management system (System), attached hereto and incorporated herein, that must meet the regulatory requests of Grantee.
- D. Grantor and Grantee hereby covenant and agree as follows:

1.0 Construction

1.1 In connection with Grantor's proposed development of the Property, Grantee has required and Grantor has agreed to construct a System. The System is described and shown on a construction drawing prepared by the engineering firm of _____, approved by the City on Permit No. _____, 20____, and as conditioned under

1.2 As a condition of project approval, Grantor agrees, pursuant to this Agreement to ensure that the System is constructed and, where herein indicated, maintain specified components of the System.

2.0 Maintenance of Specified Components

Grantor, its heirs, successors or assigns agree to maintain, at his or her sole cost, the System and its internal and external appurtenances, placed in the right-of-way or on private property, including designated common areas, in their entirety, in perpetuity, and in accordance with this Covenant, the approved construction plans, the approved maintenance plan (attached), the manufacturer's recommendations, Kelso Municipal Code 13.08, and the Stormwater Management Manual for Western Washington (SWMWW) or comparable standards approved by the Grantee.

3.0 Records

After recording return to:

City of Kelso
 P.O. Box 819
 203 S. Pacific Ave., Suite #205
 Kelso, WA 98626

CITY OF KELSO
 STORMWATER IMPROVEMENT
 RESTRICTIVE COVENANT
 (For Commercial Sites and Subdivisions)

Grantor (owner): _____

Grantee: City of Kelso _____

Legal Description: _____

Assessor's Property Tax Parcel/Account No(s): _____

Subdivision/Site Plan Review Case No.: _____

THIS STORMWATER IMPROVEMENT RESTRICTIVE COVENANT (this "Covenant") is made this _____ day of _____, 20____, by _____ ("Grantor") and the City of Kelso, a Washington municipal corporation ("Grantee").

The Grantor, its heirs, successors or assigns, agree to provide to the City, by January 31st of each year, complete records of the inspection and maintenance performed on the system during the preceding year. These records shall document, at a minimum, the date and location of all inspections, cleaning, and any other measures taken as part of maintenance of the System.

4.0 No Removal
 No part of the System shall be altered or removed except as necessary for maintenance, repair or replacement, except as may be agreed to in writing by the parties.

5.0 Access
 Each drainage structure shall be designed and built in accordance with the approved plans to permit Grantor and Grantee access to the System at all times. Grantor shall provide the right of access to the property for the purpose of inspecting the System and for maintenance. Grantor shall provide the right of access to the System for anything to contrary in this Agreement. Grantee's right to access the System is limited to the System area only. Grantee acknowledges that Grantee has no right to access any portion of the Property that is outside of the System area; additionally, Grantee's access to the System area shall not interfere with Grantor's business operation on the Property.

6.0 Failure to Maintain
 If Grantor fails to adequately maintain or repair the specified components, Grantee shall provide Grantor with written notice of such failure to adequately maintain or repair the System. If Grantor fails to adequately maintain or repair the System within a reasonable opportunity (no less than 60 days) to adequately repair the System, Grantee shall have the right to, in an emergency, Grantee has the right to repair the System without notice to Grantor. In the event Grantee performs any maintenance or repair on the System, Grantee shall charge Grantor and provide a detailed itemized invoice together with a copy of all invoices paid by Grantee for such repair or maintenance, and Grantor shall pay the reasonable costs of such work. If Grantee is required to bring action to recover such costs, Grantee shall also recover its reasonable attorney's fees and costs, together with interest at the rate of twelve percent (12%) per annum.

7.0 Enforcement
 This Agreement may be enforced by Grantee in law or equity against the Grantor, its heirs, successors and assigns.

8.0 Successors and Assigns
 These obligations shall run with the Property and be binding upon the Grantor, its heirs, successors and assigns.

9.0 Effective Date
 This Agreement is effective on the date first written above.

10.0 Attachments [example only]
 Attachment 1: Site Stormwater System Manual

GRANTOR: _____

 Title _____
 Title _____

GRANTEE:
 CITY OF KELSO

 Title _____
 Title _____

STATE OF WASHINGTON)
 COUNTY OF _____) ss

I certify that I know or have satisfactory evidence that _____ (Grantor) is the person who appeared before me, and said person acknowledged that he/she signed this instrument, on oath stated that he/she was authorized to execute the instrument, and acknowledged it as the _____ (Title) of _____ to be the free and voluntary act of such party for the uses and purposes mentioned in the instrument.

DATED: _____

 Print name: _____
 NOTARY PUBLIC
 My commission expires: _____

STATE OF WASHINGTON)
 COUNTY OF COWLITZ) ss

I certify that I know or have satisfactory evidence that _____ (Grantee) is the person who appeared before me, and said person acknowledged that he/she signed this instrument, on oath stated that he/she was authorized to execute the instrument and acknowledged it as the _____ (Title) of _____ to be the free and voluntary act of such party for the uses and purposes mentioned in the instrument.

DATED: _____

 Print name: _____
 NOTARY PUBLIC
 My commission expires: _____

Approved as to form: _____

 City Attorney

Chapter 3

Streets

Table of Contents

Description	Page No.
3.00 Functional Classification	1
3.01 Access	2
3.02 Intersections, Driveways, and Approaches	4
3.03 Street Widths	11
3.04 Surfacing Requirements	17
3.05 Design Speed	19
3.06 Horizontal Alignment	19
3.07 Vertical Alignment	19
3.08 Transitions	21
3.09 Dedications and Guarantees	21
3.10 Private Streets	23
3.11 Street Frontage Improvements	27
3.12 Street Ends	30
3.13 Medians	33
3.14 Sight Obstruction Requirements	33
3.15 Survey Monuments	34
3.16 Sidewalks	34
3.17 Multi-Use Trails	34
3.18 Bridges	35
3.19 Landscaping in the Right-of-Way, Easements, and Access Tracts	36
3.20 Street Illumination	41
3.21 Traffic Control and Signing	42
3.22 Appurtenances	44
3.23 Franchise Utilities	44
3.24 Trench Backfill and Restoration	44
3.25 Speed Humps	45
3.26 Parking Facilities	49

CHAPTER 3 – STREETS

Description	Page No.
Figures	
Figure 3-1: Corner Lot Setback	7
Figure 3-2: Major Arterial	11
Figure 3-3: Minor Arterial	12
Figure 3-3a: Industrial Minor Arterial	12
Figure 3-4: Collector	13
Figure 3-4a: Industrial Collector	13
Figure 3-4b: Industrial Collector with Ditch	14
Figure 3-5: Local Multi-family Area	14
Figure 3-6: Local Single-family Areas	15
Figure 3-6a: Local Traffic Calm	16
Figure 3-6b: Roadway with Rain Gardens	16
Figure 3-7: Alleys: Commercial & Industrial	17
Figure 3-8: Alleys: Residential	17
Figure 3-9: Private Street Type I	24
Figure 3-10: Private Street Type II	25
Figure 3-11: Private Street Type III	25
Figure 3-12: Minimum Street Improvement	28
Figure 3-13: Cal-de-Sac Dimensions	31
Figure 3-14: Temporary Cal-de-Sac	32
Figure 3-15: Bioretention Planting Zones	41
Figure 3-15: Trench Patch	45
Figure 3-16: Interior Parking Area Layout Example (without pedestrian walkways)	53

Tables	
Table 3.1: Unsignalized Intersection Spacing	6
Table 3.2: Minimum Distances from Corner Standards	7
Table 3.3: Curb Return Radii (Feet) Edge of Pavement/Curb - Minimums	10
Table 3.4: Major Arterial Surfacing Requirements	18
Table 3.5: Minor Arterial Surfacing Requirements	18
Table 3.6: Collector Street Surfacing Requirements	18
Table 3.7: Local Street and Alley Access Surfacing Requirements	18
Table 3.8: Vertical Alignments and Flood Plains	21
Table 3.9: Street Tree List	37
Table 3.10: Bioretention Plant List	39
Table 3.11: Parking Stall and Aisle Dimensions	50

3.00 Functional Classification

The functional classification of existing and proposed roads is established by the City on an individual basis using the existing land use and existing operational characteristics. The Director will maintain a map that classifies each roadway. Kelso classifies roads and streets as follows:

A. Major Arterial

These facilities are the supporting elements of both the arterial routes and collector systems. Major arterials, in combination with minor arterial routes, are intended to provide a high level of mobility for travel within the region. All trips from one sub-area through an adjacent sub-area traveling to other points in the region should occur on a major arterial.

Access is generally limited to intersections with other arterials and collectors; direct residential access is not permitted. Direct land access is discouraged, kept to a minimum, and controlled. The level of fixed route transit service is high.

B. Minor Arterial

The minor arterial system complements and supports the major arterial system, but is primarily oriented toward travel within and between adjacent sub-areas. An adequate minor arterial system is needed to ensure that these movements do not occur on major arterials. These facilities provide connections to major activity centers and provide access from the major arterial systems into each sub-area.

They serve through traffic and provide direct access for commercial, industrial, office, and multi-family development, but generally, not for residential properties. Access to abutting lots is limited. Since minor arterials serve a more localized area, fixed route transit is moderate.

C. Collector

Collector streets connect local traffic within a subarea to arterial roads. Service to adjacent land uses is subordinate to traffic movement. Access to abutting properties and parking is controlled through the use of raised channelization, driveway spacing, bicycle and/or pedestrian lanes, and pavement markings. Typically, collector streets are not continuous for any great length, nor do they form a connected network by themselves. Since collector streets connect arterial networks and also connect neighborhoods to commercial areas as well as each other, fixed route transit service is low. Access to abutting lots is limited.

D. Local: Multi-family Areas

Local: Multi-family streets serve to distribute traffic from collectors and provide direct access for abutting properties. Through trips are discouraged and parking is allowed.

E. Local: Single-family Areas

Local: Single-family streets provide access to adjoining properties within a neighborhood. Through trips are discouraged and parking is allowed. Service a very limited number of houses.

F. Alleys (Commercial & Industrial, Residential)

Alleys provide service access to adjoining properties through one-way traffic. Through trips and parking are not allowed. No fixed route transit usage and the focus is for service and localized access. Service a very limited number of lots.

3.01 Access

The Director shall have the authority to limit access and designate access locations on public streets under the jurisdiction of the City. When a parcel has multiple roadway frontages, access shall be granted from the lesser classification roadway. Access to streets and highways under Cowlitz County or State of Washington jurisdiction must be formally approved by those entities at the applicant's initiative and expense.

A. Request Process

1. Applications. Applicants may request a street access connection permit as part of an underlying Development application, or they may file separately for a street access connection permit if the connection is being requested without relation to an underlying land use application.

2. Approval. The issuance or denial of the street access connection permit shall be made administratively by the Director.

3. Submittal Requirements for Street Access. Per KEDM Section 1.04.K.

4. Permit Issuance. In order to receive a street access connection permit the applicant must comply with the following:

- a. The design standards for the functional classification of the roadway that the proposed connection will access.
- b. If the proposed connection is an expansion or change of use of a pre-existing non-conforming access, the applicant must demonstrate that the

proposed connection will not substantially adversely affect the safety of the roadway section that the proposed connection will access through an interim access permit application.

c. Pursuant to the Washington State Environmental Policy Act (SEPA), the City shall have the authority to impose conditions upon the permit to mitigate the specific adverse impacts created by the connection.

5. Variance from Access Standards. The Access Standards may be modified by the Director on the street access connection permit upon a showing by the applicant of the following:

a. Topography, right-of-way, existing construction or physical conditions, or other geographic conditions impose an unusual hardship on the applicant, and an equivalent alternative which can accomplish the same access management purpose is available.

b. A minor change to a standard is required to address a specific design or construction problem, which if not enacted, will result in an unusual hardship.

c. An alternative standard is proposed which is equal to or superior to these standards.

d. Application of the standards of this chapter to the development would be grossly disproportional to the impacts created.

6. Interim Access. When and if a property/parcel cannot meet current access spacing standards, an interim access permit may be pursued. The purpose of the interim access permit is to allow access (that does not meet approved access spacing standards) to a property until such time when acceptable access spacing standards can be met. An interim access permit shall be granted upon meeting the following criteria:

a. Access to the property/parcel cannot meet current access spacing criteria;

b. The interim access shall be evaluated for traffic operations (including queuing) and safety criteria and shall meet minimum transportation operating conditions and not create an adverse safety situation (dependent upon review from the City Traffic Engineer).

c. The property owner agrees to sign a waiver of the right to demonstrate against the formation of a local improvements district, or similar financing mechanism, for the primary purpose of providing roadway infrastructure to help create a network that would allow for adequate access to the parcel that meets current access spacing standards. Once that infrastructure is in place the interim access would be closed.

- d. The property owner records an agreement with the City, County and/or WSDOT to participate in efforts to achieve adequate access that meets access spacing standards to help eliminate the interim access.
 - e. The property owner agrees to vacate (and close) the interim access when an appropriate alternative access is identified and constructed which meets the current access spacing criteria.
 7. **Suspension.** The Director shall have the right to suspend a street access connection permit where the applicant fails to comply with the conditions and access standards of the street access connection permit. The street access connection permit can be reinstated upon compliance with conditions and access standards of the street access connection permit. If after 180 days the applicant has failed to comply with conditions, the Director has the right to revoke the street access connection permit.
- 3.02 Intersections, Driveways, and Approaches
- A. General Requirements
1. Standard residential, commercial, or industrial driveway approaches shall be required for all driveways accessing onto a public (or private) right-of-way or easement.
 2. A private intersection opening may be used in lieu of a conventional driveway approach in commercial and industrial areas where all of the following criteria are met:
 - a. Projected driveway usage is greater than two-thousand (2,000) vehicles per day.
 - b. In any case where traffic signalization is approved, warranted, and provided.
 - c. A minimum one-hundred (100) foot storage area is provided between the street and any turning or parking maneuvers within the development.
 - d. The opening is at least one-hundred and fifty (150) feet from any other intersection opening, including driveways on or off the property frontage and under control of the applicant or not.
 - e. Easement dedication for traffic control devices is provided.

B. Conditions of Approval

1. Driveways directly giving access onto arterials shall be denied if alternate access is available.

2. All abandoned driveway areas on the street frontage to be improved shall be removed and new curb, gutter, and sidewalk shall be installed.
 3. No commercial or industrial driveway shall be approved where backing onto the sidewalk or street will occur.
 4. No driveway shall be approved where backing onto a street might occur if the slope of the driveway is greater than ten percent (10%) within the first twenty (20) feet of the property line.
 5. Left turns from and to a driveway may be restricted as a development condition or in the future if such maneuvers are found to be unduly hazardous.
 6. Driveways approaches shall be aligned, wherever practicable with existing driveways on the opposite side of the street.
 7. All driveways shall be angled ninety-degrees (90°) to the street, unless otherwise approved by the Director.
- C. Intersection/Driveway Spacing. Intersections are divided into two categories for determining spacing requirements: signalized access spacing and unsignalized access spacing, which include both driveways and intersections.
1. **Number of Driveways Approaches per Property.** Property owners shall be granted one access per property. Design modification requests for additional driveways must be supported by a traffic impact study. Any additional access should conform to the KEDM. If the property has frontage along two or more streets, access shall be from the lower classification street unless approved through the design modification process. Final approval of access (per property) shall be through the Director.
 2. **Signal Spacing.** Signalized access on all roadways shall be no less than 1,250 feet for full access, and should maintain adequate signal progression.
 3. **Measurement of Access Spacing.** Spacing of signalized and unsignalized roadway intersections, as well as driveways, are described in Table 3.1 and shall be measured from the centerline of the intersections being measured. Distances from intersection corners for access driveways as described in Table 3.2 shall be measured between the nearest edges of the driveways, edges of roadway or curb line. Where the distance required from the corner is greater than the parcel frontage, the driveway approach shall be placed at the furthest distance from the adjacent driveway.

Table 3.1
Unsignalized Intersection Spacing

Roadway Classification	Minimum Full Access Spacing (ft)	Maximum Full Access Spacing (ft)	Right-in/Right-out Access Spacing (ft)
Major Arterial	1,250	2,000	400
Minor Arterial	600	1,000	300
Collector	400	800	200
Local Multi-Family	100	500	n/a
Local Single-Family	25	500	n/a

In the case of long or oddly shaped blocks and to facilitate pedestrian access to parks, playgrounds, open space or schools, the applicant shall construct pedestrian paths of not less than ten feet in width on a dedicated right-of-way or perennially unobstructed easement of not less than twenty feet in width, to extend through the block(s) at location(s) deemed necessary by the Director.

- D. Access from Alleys. There shall be no access from alleys except where the intersecting and parallel streets are classified as Local Access Residential. On Local Access Residential streets, one alley access shall be permitted whose width shall conform to the standard widths for a driveway if the alley access is the only access for the residence.
- E. Corner Standards. Driveways approaches on corner parcels shall be placed on the roadway with the lower classification. If both roadways have the same classification, the Director shall determine on which roadway the driveway shall be located. It may be necessary to perform a queuing analysis to determine if the queue on the roadway where access is being requested blocks the proposed access.

Table 3.2
Minimum Distances from Corner Standards

Functional Classification	Minimum Access Set-back from Corner (ft)
Major Arterial	300
Minor Arterial	200
Collector	100
Local	50

The corner point from which to measure is the curb return radius and is shown in Figure 3-1. Where the distance required from the corner is greater than the parcel frontage, the driveway shall be placed at the furthestmost distance from the intersection.

Figure 3-1. Corner Lot Setback

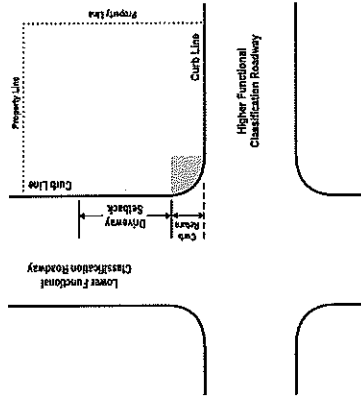

- F. Sight Triangles for All Uses in All Zones. The corner areas of lots adjacent to street intersections as well as the corner areas adjacent to road approaches and other access easements shall be kept clear of all obstructions, as denoted below.
1. All corner building sites shall maintain a clear triangle at the intersection with the street rights-of-way to assure traffic safety. No building, structure, object or growth over thirty-six inches in height, measured from the mean grade of the intersecting street, shall be allowed within this triangle. The triangle shall be computed as follows: Starting at the apex of the intersecting street rights-of-way, measuring down the triangle legs thirty feet; the base of the triangle shall be found by drawing a straight line connecting the triangle legs. The land inside the triangle shall be regulated for visibility.
 2. All other lots not identified as corner lots shall be considered as mid-lots for the purpose of sight line development and regulation. The mid-lot sight line setback area shall be computed as follows: Starting at the intersection of the driveway centerline and the fronting street lot line, measure fifteen feet in opposite directions. From these points draw a straight forty-five-degree line back to the driveway centerline. The land inside the triangle shall be regulated for visibility. No building, structure, object or growth over thirty-six inches in height, as measured from the mean grade of the fronting street, shall be allowed in this triangle.
- G. Restrictive Median Curbs. Except for Local Access and Local A access Residential roadways, restrictive median curbs shall be used to restrict turning and crossing movements as follows:
1. If access spacing outlined in Tables 3.1 and 3.2 cannot be met, median barrier curbs shall be installed of sufficient length to restrict left turn and crossing movements, or between full access intersections, whichever is greater.
 2. At signalized intersections on principal arterials, the length of restrictive median curbs shall be equal to the driveway spacing distance determined by Table 3.2, regardless whether or not driveways exist.
 3. At intersections with left turn lanes on principal arterials, minor arterials, and neighborhood collectors, the length of restrictive median curbs shall be equal to the left turn lane storage length, except as may be required by condition number 2 above.
 4. The respective Director shall determine restrictive median curb types and placements.

H. Turn Lane Warrants

1. Turn lanes (left and right) may be warranted at unsignalized intersections, and should be evaluated using appropriate left or right turn lane warrants utilizing standards adopted by the City or State depending on which facility is being analyzed.
 2. At signalized intersections, a traffic impact study should be used to determine required storage length for left or right turn lanes.
- I. Driveway Design Criteria:
1. Width.
 - a. Two-way multi-family residential driveways shall have a minimum width of sixteen (16) feet and a maximum width of twenty-two (22) feet. Where intersection openings are approved the width shall be as determined by the Director. One-way multi-family residential driveways shall have a minimum width of ten (10) feet and a maximum width of twelve (12) feet. Parking lot circulation needs shall be met on site. The public right-of-way shall not be utilized as part of a one-way parking lot flow.
 - b. Two-way commercial/industrial driveways shall have a minimum width of twenty-four (24) feet and a maximum width of twenty-eight (28) feet. Where intersection openings are approved the width shall be as determined by the Director. One-way commercial/industrial driveways shall have a minimum driveway width of twelve (12) feet with a maximum width of sixteen (16) feet. Commercial/industrial driveways shall meet the separation requirements of Section 3.02. Parking lot circulation needs shall be met on site. The public right-of-way shall not be utilized as part of a one-way parking lot flow. A wider commercial/industrial driveway width may be approved by the Director where a substantial percentage of oversized vehicle traffic is anticipated and a written request and turning diagrams are submitted. The request shall include justification for the oversized vehicles and the design vehicle selection as well as detailed alternatives and considerations that were evaluated.
 - c. A single-family driveway shall have a minimum width of nine (9) feet and maximum width of fifteen (15) feet.
 2. Clearance from structures. No object (including fire hydrants, light or power poles, street trees) shall be placed or allowed to remain within six (6) feet of the driveway wing end edge.
- Where the building facade or other design element is less than ten (10) feet behind the sidewalk, both pedestrian and vehicular sight distance shall be maintained.

- M. It is the policy of the City to have the applicant's engineer evaluate safe intersection sight distance using the principles and methods recommended by AASHTO.
- N. Traffic control will be as specified in the Manual of Uniform Traffic Control Devices (M.U.T.C.D.) or as modified by the Engineer as a result of appropriate traffic engineering studies.
- O. Traffic signal modification, relocation, or installation is required when roadway or driveway geometrics interfere with existing signal facilities, or would result in an un-signalized approach, or intersection that meets signal warrants.

3.03 Street Widths

The figures below show the road width standards by the functional classification of the road. Authority to determine a street's class shall lie with the Director. It should be noted that public utility easements beyond the right-of-way are typically required.

Lane configuration shall be compared to existing conditions and determined at the time of construction drawing approval.

Additional right-of-way and pavement width may be required, in addition to that shown in Figures 3-2 through 3-6, to allow parking, LID, turn lanes and median strips. Additional right-of-way or easements may be required for cut or fill embankments. Bioretention curb extensions may be located in the parking lane with approval of the Director to reduce the need for additional right-of-way.

Figure 3-2. Major Arterial
Design Speed 35 mph

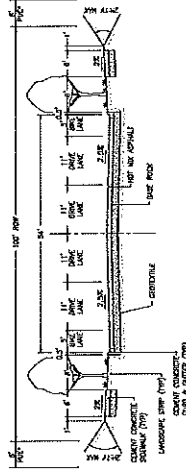

*60' ROW unless otherwise approved
*66' mixed width to accommodate 112' center turn lanes when determined necessary by the Director

- 3. Sight Distance. Sight distance shall be designed per AASHTO guidelines.
- 4. A landing shall be provided in accordance with KEDM Section 3.07.
- 5. A single-family residential driveway less than 100 feet in length may be designed as a ribbon (two-track) driveway. A commercial driveway less than 100 feet in length may be designed as a ribbon (two-track) driveway with approval of the Director.

J. Permeable Pavement. Use of permeable pavement for commercial driveways is encouraged where feasible in accordance with the SWMMWW.

The following specifies the minimum requirements for intersections:

K. Angle between intersections.

The interior angle at intersecting streets shall be kept as near to ninety degrees (90°) as possible and in no case shall it be less than seventy-five degrees (75°), nor more than fifteen degrees (15°) from the ninety (90°). A tangent section shall be carried a minimum of fifty (50) feet each side of intersecting right-of-way lines. When possible, intersections shall align with any existing intersection on the opposite side of the street.

L. Curb returns.

Minimum curb radii at intersections shall be shown in Table 3.3 for the various functional classifications. The right-of-way radii at intersections shall be sufficient to maintain at least the same right-of-way to curb spacing as the upper classified street.

Sidewalk access ramps shall be provided at all corners of all intersections, regardless of curb type.

Table 3.3
Curb Return Radii (Feet)
Edge of Pavement/Curb - Minimums

Street Classification	Major/Minor Arterial Street	Collector Street	Local Streets
Major/Minor Arterial Street	25	25	25
Collector Street	25	20	20
Local Streets	25	120	15

Figure 3-3. Minor Arterial
Design Speed: 35 mph

*K. P.T.E. unless otherwise approved.

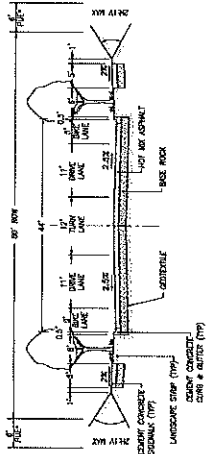

Figure 3-3a. Industrial Minor Arterial
Design Speed: 35 mph

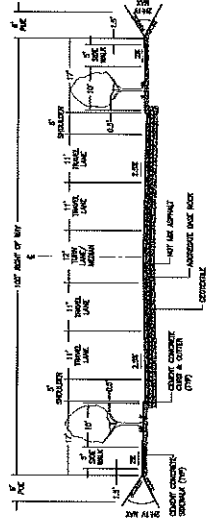

Figure 3-4. Collector
Design Speed: 25 mph

*K. P.T.E. unless otherwise approved.

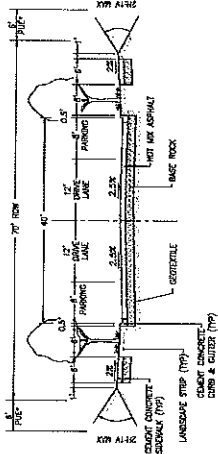

Figure 3-4a. Industrial Collector
Design Speed: 25 mph

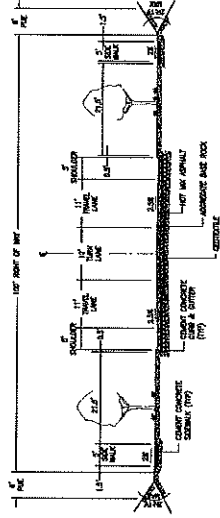

Figure 3-4b: Industrial Collector with Ditch
Design Speed: 35 mph

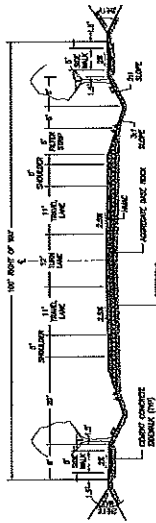

Figure 3-5: Local Multi-family Area
Design Speed: 25 mph

25' PUF unless otherwise addressed

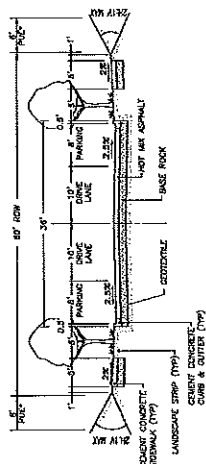

Figure 3-6: Local Single-family Areas
Design Speed: 25 mph

25' PUF unless otherwise addressed. Utilities may be placed under the sidewalk in new subdivisions with approval of the Director. If on-site bioretention is used to manage stormwater on residential lots.

Alternate pavement widths may be allowed in new subdivisions with approval of Director and Fire Marshal. Sidewalks may be allowed on one side of the road in new subdivisions with approval of the Director.

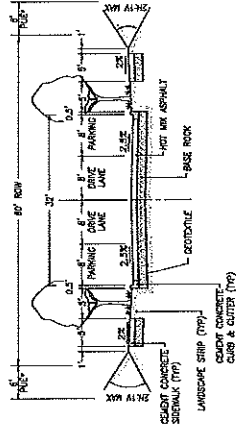

Figure 3-6a. Local Traffic Calming
 Design Speed: 25 mph

Alternate pavement widths may be allowed in new residential single-family subdivisions with approval of Director and Fire Marshal.

Sidewalks may be allowed on one side of the road in new single-family residential subdivisions with approval of the Director.

Utilities may be placed under the sidewalk in new subdivisions with approval of the Director, if on-site bioretention is used to manage stormwater on residential lots.

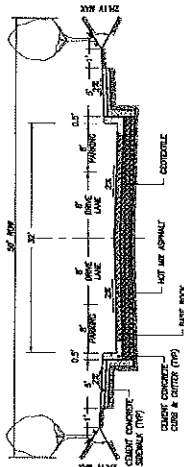

Figure 3-6b. Roadway with Rain Gardens

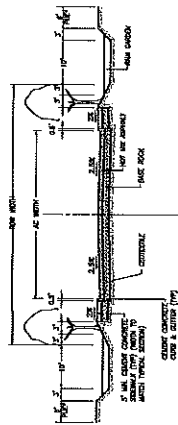

Figure 3-7. Alleys: Commercial & Industrial
 Design Speed: 25 mph

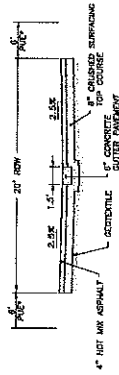
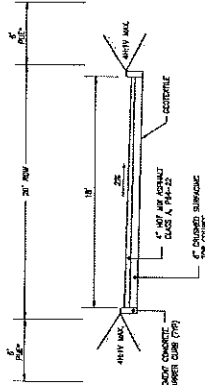

Figure 3-8. Alleys: Residential
 Design Speed: 25 mph



3.04 Surfacing Requirements

The pavement structure thickness identified for these soil and roadway types is required unless a site-specific pavement design is done. The total pavement structure shall not exceed two and one half (2.5) feet. Asphalt concrete pavement shall be hot mix concrete (HMA) Class A, PG 64-22 per the Standard Specifications. Subgrade reinforcement geotextiles shall be installed prior to constructing the base and surfacing.

Table 3.4
Major Arterial
Surfacing Requirements

AAASHTO Soil Type	Hot Mix Asphalt Thickness	Base Rock Thickness
A-1 – A-3	0.55'	0.55'
A-4 – A-7	0.60'	1.35'
Other	No Section Estimated	

Table 3.5
Minor Arterial
Surfacing Requirements

AAASHTO Soil Type	Hot Mix Asphalt Thickness	Base Rock Thickness
A-1 – A-3	0.50'	0.50'
A-4 – A-7	0.50'	1.45'
Other	No Section Estimated	

Table 3.6
Collector Street
Surfacing Requirements

AAASHTO Soil Type	Hot Mix Asphalt Thickness	Base Rock Thickness
A-1 – A-3	0.45'	0.45'
A-4 – A-7	0.45'	1.15'
Other	No Section Estimated	

Table 3.7
Local Street and Allev. Access
Surfacing Requirements

AAASHTO Soil Type	Hot Mix Asphalt Thickness	Base Rock Thickness
A-1 – A-3	0.35'	0.50'
A-4 – A-7	0.35'	0.90'
Other	No Section Estimated	

3.05 Design Speed

The minimum design speed for each road classification shall be as shown in Figures 3-2 through 3-4 or as otherwise approved by the Director.

3.06 Horizontal Alignment

A. General Design

1. Horizontal alignment shall be designed per AASHTO guidelines.
2. Super elevations may only be used with the written approval of the Director. Where super elevation is used, street curves should be designed per AASHTO guidelines, except that the maximum super elevation rate of 0.04 shall be used.
3. Offset crown cross-sections are not acceptable as super elevation sections.

4. Streets shall be related appropriately to the topography and shall follow the more gradual natural contours of the land.

B. Residential Design

1. Streets shall be aligned to provide for continuation of streets in adjoining subdivisions and to allow for future opening of streets in possible adjoining subdivisions.
2. Streets shall be oriented within twenty-five degrees of east-west to the maximum extent possible to enhance solar access to residences. If other considerations such as topography and contours or connection with existing principal streets adversely affect this standard then alternatives may be considered. This may include assurance that the majority of lots have their axes oriented north-south regardless of the angle of incidence of lot lines with street lines.
3. Direct driveway access to major arterials shall be prohibited, and direct driveway access to minor arterials and collectors shall be minimized. A buffer strip may be used and a separated service or marginal access road may be utilized.

3.07 Vertical Alignment

A. Street alignments shall meet the following requirements:

1. Minimum tangent street gradients shall be one-half percent (0.5%) along the crown and curb.

2. Maximum street gradients shall not exceed fifteen percent (15%) for residential streets, ten percent (10%) for collector streets, and seven percent (7%) for arterials;
 3. Minimum street gradients shall be at least one-half percent (0.5%) along the gutter.
 4. Long sweeps of more than ten percent (10%) shall be avoided.
 5. Local streets intersecting with a collector or greater functional classification street or streets intended to be posted with a stop sign shall provide a landing averaging five percent (5%) or less and must meet ADA Guidelines where applicable. Landings are that portion of the street within twenty (20) feet of the projected curb line of the intersecting street at full improvement.
 6. Commercial and industrial driveway approach landings are not to exceed two (2) feet difference in elevation for a distance of thirty (30) feet approaches an arterial or twenty (20) feet approaching a collector or industrial, measured from the back of sidewalk or the back of curb if no sidewalk exists.
 7. Grade changes of more than one percent (1%), no less than 1000 feet apart, shall be accomplished with vertical curves.
 8. At street intersections, the crown of the major (higher classification) street shall continue through the intersection. The roadway section of the minor street will flatten to match the longitudinal grade of the major street at the projected curb line.
 9. Street grades, intersections, and super elevation transitions shall be designed to not allow concentrations of storm water to flow across the travel lanes; and
 10. Streets intersected by streets not constructed to full urban standards shall be designed to match both present and future (as far as practicable) vertical alignments of the intersecting street. The requirements of this manual shall be met for both present and future conditions.
- B. When new streets are built adjacent to or crossing drainage ways, a no rise analysis (as defined by the Federal Emergency Management Agency) shall be stamped by a professional engineer and submitted to the City for review and approval. At a minimum, the following standards shall govern the vertical alignment:

Table 3.8
 Vertical Alignments and Flood Plains

Functional Classification	Vertical Standard
Arterial Streets	Travel lanes at or above the 50-year flood elevation but not lower than 6-inches below the 100-year flood elevation.
All other streets	Travel lanes at or above the 25-year flood elevation but not lower than 6-inches below the 50-year flood elevation.

Vertical curves shall be designed per AASHTO guidelines.

3.08 Transitions

- A. Street width transitions from a narrower width to a wider width shall be designed with a ten to one (10:1) taper. Street width transitions from a wider width to a narrower width shall be designed in accordance with AASHTO Standards or a ten to one (10:1) taper whichever is greater. Delineators, as defined by the MUTCD and approved by the City, shall be installed to define the configuration.

In situations where a tapered transition cannot be provided, a type III barricade shall be installed at the end of the wider section of the street and a taper shall be appointed and delineated as approved by the Director.

- B. Lane transitions shall be designed per AASHTO guidelines.

3.09 Dedications and Guarantees

- A. Right-of-way shall be dedicated for streets and other improvements as required per Figures 3-2 through 3-8 to accommodate motorized and non-motorized transportation, landscaping, utility, drainage, LID, and buffer requirements.

If the Fire Marshal and Director approve a narrower pavement width in accordance with Figure 3-6 or 3-6a, right-of-way width may be reduced accordingly.

- B. Public utility tracts and/or easements for all public systems shall be provided as required. Specific requirements for sewer, water, and storm drainage easements are detailed in the relevant chapters. Particular design features of a road may necessitate slope, wall, or drainage easements. Such easements may be required by the Director in conjunction with dedication or acquisition of rights-of-way and other

standard easements (temporary construction, right-of-entry, sidewalk, pedestrian, street lighting, and traffic control devices, etc.).

C. Special Access Easements or Tracts.

Where it is necessary to facilitate pedestrian circulation between neighborhoods, schools, shopping, or other activity centers, public access easements or tracts shall be dedicated.

Improvements to the easement shall include a sidewalk or trail consistent with other non-enclosed facilities in the area. Fences shall be constructed along access easements in residential areas where buildings will be located nearer than fifty (50) feet to the edge of the easement. Traffic diverters or bollards shall be installed at the direction of the Director.

Pedestrian access easements or tracts shall be a minimum of fifteen (15) feet wide. If the easement is over one-hundred and fifty (150) feet in length, the width shall be twenty (20) feet. Structure setbacks shall be a minimum of five (5) feet from the edge of the easement or tract.

D. All subdivisions and short subdivisions (short plats) will be required to deed additional right-of-way, as a condition of approval of the subdivision, where the existing right-of-way for a public street is not adequate to incorporate necessary frontage improvements for public safety and provide compatibility with the area's circulation system.

All short subdivisions (short plats) will be required to deed additional right-of-way, as a condition of approval of the short plat, under one or more of the following conditions:

1. The short plat abuts an existing substandard public street and the additional right-of-way is necessary to incorporate future frontage improvements necessary for public safety, or
2. Additional right-of-way is needed to provide right-of-way for the extension of existing public street improvements necessary for public safety, or
3. Additional right-of-way is needed to provide future street improvements necessary for public safety for planned new public streets.

E. All recording costs for easements created by private development shall be borne by the applicant.

F. Prior to commencing construction of any component of the public street or sidewalk, the applicant shall submit to the City an approved performance bond in accordance with the requirements of Section 1.03 of the KEDM.

3.10 Private Streets

A. Criteria for Authorization. It is the City of Kelso's policy to discourage private streets and to only permit them under unusual circumstances. Private streets may be permitted only if they meet all the following conditions:

1. A road modification for the street has been approved by the Director;
2. Covenants have been approved, recorded, and verified with the City which provide for maintenance of the private streets and associated parking areas by owners in the development. Covenant shall include a periodic maintenance schedule, be enforceable by any property owner served by that road, include a formula for assessing maintenance and repair costs, shall run with the land;
3. Provisions are made for the streets to be open at all times for emergency and public service vehicles;
4. The private streets will not obstruct public street circulation; and
5. The following conditions exist:
 - a. The plat or short plat street will ultimately serve no more than fifty (50) single family lots or the roadways serve commercial or industrial facilities where no circulation continuity is necessary; and
 - b. The Director determines that no other access is available and the private road is adequate for the area it is to service,
 - c. The private road shall not connect two public roads,
 - d. No public utilities shall be located within the private street without approval from the Director.

B. Notice. A statement is required on the face of any plat or short plat and in the CORs containing a private road with the following: "The City of Kelso has no responsibility to improve or maintain the private roads contained within, or private roads providing access to the property described in this plat."

C. Easements. Private streets shall be constructed within easements with an easement width of sixty (60) feet. If the applicant does not own the property in which the easement crosses a modification may be applied for in accordance with Chapter 12

of the KMC. Easements shall be expanded in width as may be necessary to include all curbs, fill, turnouts and turnarounds as required.

D. Turnarounds. Turnarounds shall be provided at the end of all private streets longer than one-hundred and fifty (150) feet and at one-thousand foot intervals along the length of a private street where no intersecting roadway exists. Turnarounds shall have a minimum radius of forty (40) feet and all interior corners shall have a minimum radius of twenty-five (25) feet.

E. Grading. All filling and grading associated with the construction of a private road shall be conducted in accordance with current WSDOT Standard Specifications for Roads and Bridges. A geotechnical report, prepared by a qualified expert shall be provided for any grading which will incorporate cutting or filling in excess of five (5) feet, cut slopes in excess of one vertical to two horizontal (2:1), or fill slopes in excess of one vertical to two horizontal (2:1). Such report shall identify materials to be used, compaction rates and methods, maximum allowable slopes, and erosion control methods.

F. Construction Requirements. Private streets shall conform to public street construction standards with the following exceptions:

Figure 3-9: Private Street Type I
 20-50 Residential Units

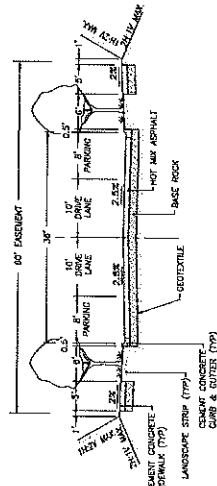

Figure 3-10: Private Street Type II
 10-19 Residential Units

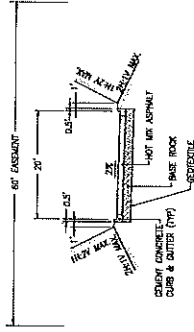
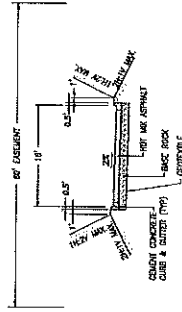

Figure 3-11: Private Street Type III
 2-9 Residential Units



1. The maximum grade for Type II and Type III private streets shall be twelve percent (12%) for a gravel surface and fifteen percent (15%) for a paved surface.

2. Private streets shall be designated by a sign stating the name of the road and "Private Roadway".

3. Intersection of a private street with another private street shall be constructed per the most restrictive requirements of the two intersecting roads. The

approach to the intersection shall be as level as possible in all directions for a minimum of fifty (50) feet. Curb returns shall have a minimum radius of fifteen (15) feet.

4. Intersections with public streets shall be constructed with a driveway drop; have interior angles no less than seventy-five (75) degrees; a maximum gradient of four percent (4%) shall be maintained for a minimum of twenty-five (25) feet. If the minimum gradient cannot be achieved, an alternate solution showing fifty-foot paving shall be submitted for approval. The approaching private street shall have a minimum of four (4) inches of HMA, twelve inches of crushed surfacing top course, underlain by geotextile fabric. The width of this section shall be a minimum of twenty-four (24) feet with one (1) foot gravel shoulders.

5. Intersection with state roadways shall at a minimum comply with the requirements for city intersection above and shall require the approval of the appropriate agency prior to construction.

6. A drainage report shall be provided for all Type I and Type II roadways. Drainage of surface water shall be accomplished by either an enclosed system or a series of ditches and/or culverts. Drainage water from any private road shall not be discharged directly to streams. All stormwater design must comply with Chapter 4.

7. All work must be completed in accordance with the erosion control standards as set forth in Chapter 2.

8. Any bridge on a Type II roadway shall be constructed to the AASHTO and/or state standards, whichever is more restrictive. Any bridge on a Type III shall be built to a bridge design standard as specified in the International Building Code using live loading and/or span, standards whichever is more restrictive.

- G. Acceptance as Public Streets. Acceptance of private streets as public streets will be considered only if the street meets all applicable public street standards contained herein.

- H. Maintenance. The City will not maintain roadways, signs or drainage improvements on private roads. A private maintenance covenant recorded with the county auditor will be required for any private road. The covenant shall set out the distribution of expenses, remedies for noncompliance with the terms of the agreement, right of use easements and other considerations. The covenant shall include the following terms:

1. The covenant shall establish minimum annual assessments in an amount adequate to defray costs of ordinary maintenance and procedures for approval of additional needed assessments.

2. The covenant shall include a periodic maintenance schedule.
 3. The covenant for maintenance shall be enforceable by any property owner served by that road.
 4. The covenant shall establish a formula for assessing maintenance and repair costs equitably to property owners served by the private road.
 5. The covenant shall run with the land.
 6. Maintenance shall include, but not be limited to, road surfacing, shoulders, signs, storm drainage facilities and control.
- The requirements of maintenance agreements on existing private roads will be determined on legal viability.

3.11 Street Frontage Improvements

- A. All developments shall install street frontage improvements at the time of construction as detailed in their approval, or as directed by the Director. Such improvements shall include, but not be limited to, curb and gutter, sidewalk, storm drainage, street lighting system, utility undergrounding (location may be required), and street and/or right-of-way widening per the KEDM. Traffic signal modification, relocation or installation, landscaping and irrigation may also be required. The frontage street shall be reconstructed from the center line of the proposed street width.

- B. Corner parcels shall provide full half street frontage improvements on arterials roadways and be evaluated according to 3.10C for each non-arterial fronting street
- C. Frontage improvements shall include a two (2) inch inlet of the half width, if construction invades the opposite side of the street.

- D. Subdivisions under 4 lots and site plans under five thousand (5,000) square feet shall be required to provide full half-street frontage improvements along arterial roadways and shall at a minimum be required to match the predominant characteristic/condition of the existing non-arterial fronting roadway, where the majority of the parcels are developed.

The predominant existing or potential condition shall be defined by considering the existing frontage conditions for all parcels fronting the half-street without development or redevelopment potential; if less than fifty percent (50%) have frontage improvements or partial improvements only, the subject development shall meet that standard. Where fifty percent (50%) or more have full improvements, or the potential for development or redevelopment, half-street frontage improvements shall be required.

In situations where the Director finds that other pending or approved unconstructed developments on the same street frontage would cause the calculation in 3.10C to exceed fifty percent (50%) or where other recorded covenants requiring frontage improvements exist, or where it is determined that deferral will cause an adverse impact or create dangerous or hazardous conditions, the Director may require half-street frontage improvements.

In situations where the applicant is required to match the existing characteristic/condition of the existing non-arterial, the minimum frontage shall resemble the following:

Figure 3-12: Minimum Street Improvement

Street trees shall be selected from the Street Tree List.

A street tree may be planted within a boulevard BMP when bio-retention is placed in the right-of-way to maintain stormwater runoff in accordance with Chapter 2.

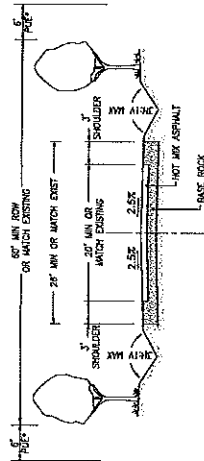

E. To allow for reasonable development, half-street improvements may be approved by the Director. Whenever a half-street improvement is approved, it shall conform to the following:

1. Street section design and construction shall be in conformance with the KEDM.
2. Minimum pavement width shall be 24 feet for arterial, collector and industrial streets, and 20 feet for residential streets.
3. Intersection improvements shall be adequate to provide turn lanes.

- a. Arterials, collectors and industrials: 40 feet paved width, or the required width for the street (whichever is less), for 250 feet as measured from centerline of the intersecting street
- b. Residential: 36 feet paved width, or the required width for the street (whichever is less), for 150 feet as measured from centerline of the intersecting street

F. The following minimum standards shall apply to the development of single family residential dwelling units on an unimproved right of way (existing plats), and private roads:

1. The existing right-of-way width, HMA width, and sidewalk status shall be extended to match the nearest paved street. Minimum surfacing of all local private access streets shall be 3" of compacted HMA over 3" of compacted 5/8"-3" crushed top course, 4" of compacted 1-1/4"-0" crushed base rock. Compacted depths shall meet or exceed existing subgrade depth.
2. An improved turn-around shall be provided in accordance with Section 3.12 of the KEDM if the lot to be developed is located at the end of any road that is over 150 feet in length.
3. All utilities which have not already been installed to serve the site shall be constructed to full City standards as set forth in the KEDM. The list of affected utilities shall include but not be limited to water, sanitary sewer, storm drainage, electrical and communications.
4. The grades shall be established by the applicant's engineer. The HMA matching width shall be a minimum of twenty (20) feet and must meet these standards.
5. If the applicant does not or cannot bear the cost of connectivity and if the easements agreement does not apply, Council will form an LID if improvements are required as a health and safety issue. Otherwise development will not be allowed.
6. The intent of the exception for a singular lot development is to allow a private party to build and access a single family residence without the financial burden of completely developing the facilities to all the lots. Should the private party acquire an interest in the intermediate lots, he will be considered as a developer and the above exception shall not be allowed.

3.12 Street Ends

A. Cul-de-sacs:

- 1. Cul-de-sacs shall be provided at all public and private street ends on all streets that are longer than one-hundred fifty (150) feet and up to four-hundred (400) feet in length, measured from the centerline of the intersecting road to the center of the cul-de-sac. The cul-de-sac may include a planting circle in the center.
- 2. No dead end street shall be allowed that obstructs public street circulation.
- 3. All street ends shall be paved and signed "No Parking."
- 4. All requirements for utility/landscape strips and sidewalk for the adjacent street section shall apply.
- 5. The minimum curb radius for transitions into cul-de-sac bulbs shall be twenty-five (25) feet, and the right-of-way radius shall be sufficient to maintain the same right-of-way to curb spacing as in the adjacent portion of the road.
- 6. The minimum distance from center of a cul-de-sac to the subdivision boundary is one-hundred fifty (150) feet.

Figure 3-13: Cul-de-Sac Dimensions

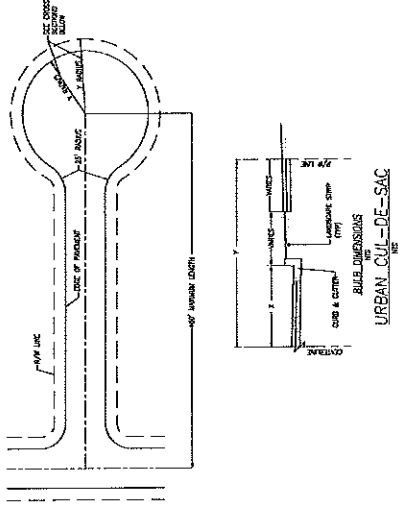

- X. 40' for residential areas
- 60' for commercial and industrial areas
- Y. 50' for local access and minor arterials
- 75' for commercial and industrial areas

B. Hammerheads:

Hammerheads may be used on private streets in lieu of a cul-de-sac. The hammerhead shall be signed "No Parking." A driveway shall not be used as part of the hammerhead.

C. Temporary Dead Ends:

Where a street is temporarily dead ended, turn around provisions must be provided where the road serves more than one (1) lot or is greater than one-hundred fifty (150) feet in length.

2. All other lots not identified as corner lots shall be considered as mid-lots for the purpose of sight line development and regulation. The mid-lot sight line setback area shall be computed as follows: Starting at the intersection of the driveway centerline and the fronting street lot line, measure fifteen feet in opposite directions. From these points draw a straight forty-five-degree line back to the driveway centerline. The land inside the triangle shall be regulated for visibility. No building, structure, object or growth over thirty-six inches in height, as measured from the mean grade of the fronting street, shall be allowed in this triangle.

3.15 Survey Monuments

At least one monument shall be placed for every intersection or every thirty (30) lots, whichever is less. Monuments shall be placed at all subdivision boundary angle points, points of curvature in streets, and such intermediate points required by the Director. Monuments shall be of concrete filled pipe or tile weighing at least 50 pounds, capped with a brass marker or radioactive marker along with the brass marker, and bearing the surveyor's registration number. Street monuments shall be set between two (2) and four (4) inches below finished street grade with a casing as set forth in the Standard Specifications.

3.16 Sidewalks

- A. All sidewalks shall be designed and constructed in accordance with the Kelso/Longview Standard Plans and Specifications.
- B. All sidewalks shall maintain the full design width around obstructions that cannot be relocated. Additional right-of-way (or easement) may be required to either relocate the obstruction or meander the sidewalk.
- C. Sidewalks shall meander no more than six (6) feet from the curb at all pedestrian crossings and at driveways.
- D. Where a sidewalk is adjacent to a bio-retention BMP or a sheet flow dispersion best management practice (BMP) proposed in accordance with Chapter 2 of the KEDM, then the sidewalk shall slope laterally to the bio-retention or the sheet flow dispersion BMP. Otherwise, the sidewalk shall slope toward the street.

3.17 Multi-Use Trails

- A. Multi-use trails shall be a minimum of ten (10) feet wide. Access easements shall comply with Section 3.08C.
- B. Surfacing shall be FIMA. Crushed rock, concrete pavers, or porous concrete may be used at the discretion of the Director.

- C. Multi-use trails shall be a minimum of six (6) feet from the edge of the vehicular travel way unless no practicable alternative exists and when approved by the Director.

- D. Maximum grade shall be dictated by the classification of the multi-use trail. Trails shall be classified as:

1. Urban Access. Urban access trails shall be constructed in accordance with the current ADA Guidelines and provide safe access between points of interest.
2. Urban Recreation. Urban recreation trails shall have a maximum grade not to exceed fifteen percent (15%). Minimum curve radius is ten (10) feet. Maximum grade may be increased to twenty percent (20%) for a maximum of one-hundred and fifty (150) feet with additional surfacing requirements and the approval of the Director.
- E. Access easement termination (Type II Barricades) shall be installed as directed by the Director. A temporary connection shall be provided to the street.

3.18 Brîges

- A. A bridge shall be defined by the National Bridge Inspection Standards published in the Code of Federal Regulations (23CFR650, Subpart C). The most current definition shall be utilized at the time of application. As of May 2007 a bridge is:

"A structure including supports erected over a depression or an obstruction, such as water, highway, or railway, and having a track or passageway for carrying traffic or other moving loads, and having an opening measured along the center of the roadway of more than 20 feet between undercopings of abutments or spring lines of arches, or extreme ends of openings for multiple boxes; it may also include multiple pipes, where the clear distance between openings is less than half of the smaller contiguous opening."

- B. Design Principles.

All bridges, whether on public or private roadways and driveways, shall meet the minimum requirements set forth in the latest addition of "Standard Specifications for Highway Bridges," adopted by AASHTO.

- C. Geometries.

In the general case, the bridge shall comprise the full width and configuration of the road being served (travelled way plus curb, sidewalk, walkway, bike lane, and/or shoulder on one or both sides). Provisions for utilities shall be required unless approved otherwise by the Director. Traffic and pedestrian railings or combination traffic-pedestrian railings shall meet AASHTO specifications. Overhead vertical

clearness on the traveled street or under overpasses shall be sixteen and one-half (16.5) feet minimum.

New and replacement bridges over natural, perennial channels shall be designed to pass the one-hundred year peak discharge from the tributary area assuming full build out. Vertical clearance between the one-hundred (100) year water surface elevation and the bottom of any part of the bridge shall be two (2) feet. All bridges shall be design in accordance with WAC 220-110-070 when applicable.

3.19 Landscaping in the Right-of-Way, Easements, and Access Tracts

- A. Plantings established in the right-of-way, including street trees, landscape strips, and bio-retention facilities, shall be maintained by the abutting property owner, except plants within a bio-retention curb extension in the parking lane shall be maintained by the City.
- B. Any existing planting areas within the right-of-way that are disturbed by construction activity shall be restored to their original condition by the applicant.
- C. Any plantings or other improvements placed within the right-of-way (by abutting property owners) are subject to removal when the right-of-way is needed for public use. The property owner is responsible for removing any landscaping or other improvements upon official notice. The property owners shall be responsible for the re-located plantings.
- D. Plantings within the right-of-way shall comply with the following provisions:
 - 1. All landscaping shall comply with the sight distance provisions of the KEDM, unless otherwise approved by the Director. No trees shall be planted within thirty (30) feet of an intersection measured from the closest curb.
 - 2. All street trees shall be from Table 3.9 below.

Table 3.9
 Street Tree List

Scientific Name	Common Name
Acer buergerianum	Trident Maple
Acer crenatum	Vine Maple
Acer glabral	Flame*
Acer griseum	Panoramic Maple
Acer negundo	Flamingo Box Elder
Acer palmatum	Japanese Maple
Acer platanoides	Globe Norway Maple
Acer tartaricum	Tataricum Maple
Arbutus menziesii	Madrone
Arbutus unedo	Strawberry Tree
Carpinus betulus	Pyramidal European Hornbeam
Cercis canadensis	Eastern Redbud
Clerodendron trichotomum	Hardening Glorybower Tree
Cornus florida	Flowering Dogwood
Cornus kousa	Kousa Dogwood
Crataegus x laevellii	Lavalle Hawthorn
Crataegus phaeopyrum	Washington Hawthorn
Fraxinus excelsior	Aureata Ash
Fraxinus pennsylvanica	Yellow Ash
Fraxinus oxycarpa	Royalwood
Ginkgo biloba	Princeton Sentry Ginkgo
Koeleria paniculata	Pyramidal Goldenrain Tree
Laburnum sp.	Goldenchain Tree
Liquidambar styraciflua	Gold Dust Sweetgum
Nyssa sylvatica*	Turkey*
Oxydendrum arboreum	Sourwood
Prunus x bhiriana	Bitternutt Plum
Prunus cerasifera	Newport Plum
Prunus cerasifera	Thundercloud Plum
Prunus calleryana	Glen's Form
Quercus alba x Q. robur	Crimson Spire Oak
Sorbus americana	Red Cascade Mountain Ash
Syrax japonica	Japanese Snowbell
Syrinx refofolata	Ivory Silk Japanese Tree Lilac
Zelkova serrata	Schmidlow
Zelkova serrata	Wireless Zelkova

* Turkey (Nyssa sylvatica) may only be used as a street tree within a bio-retention BMP. See Table 3.10 for the Bio-retention Plant List.

Table 3.10
 Bioregion Plant List

Common Name	Botanical Name	Ht. sure	Exposure	Size	Qty / Spacing	Remarks
Select plants based on zone. See Figure 3-15 for illustration of zones.						
ZONE 1: PONDING AREAS / WET TO MOIST						
TREES						
Trees optional in Zone 1. Use only in 6' width minimum facilities						
Tupelo	Nyssa sylvatica	30'	Sun/Part Shade	1.1/2" Gal.	1 per 100	Bright and varied fall color
SHRUBS						
Shrubs optional in Zone 1. Use only in 6' width minimum facilities						
Redwing	Cornus sericea	6'	Sun to Shade	1" Gal.	4 per 100	
Downy Wood Pecker	Cornus sericea	6'	Sun to Shade	1" Gal.	4 per 100	Adaptable to drought and inundation. Fall berries.
Rose	Rosa pratincola	6-8'	Sun/Part Shade	1" Gal.	4 per 100	Purple spilt flowers in summer.
Hardhack	Spiraea douglasii	4-7'	Sun/Part Shade	1" Gal.	4 per 100	
EMERGENTS (GRASSES)						
South Sedge	Carex oahuensis	1'-5'	Sun/Part Shade	1" Gal.	1 O.C., triangular	Very successful bioretention plant. Adaptable to drought and inundation.
Swamp Sedge	Carex stipitata	3'	Sun/Part Shade	1" Gal.	1 O.C., triangular	
Orange Sedge	Carex lasiocarpa	20"	Sun/Part Shade	1" Gal.	1 O.C., triangular	Orange-brown leaves provide color variation. Useful adjacent to curb or sidewalk where planer plants are desired.
Fox Sedge	Carex vulpinoidea	24"	Sun/Part Shade	1" Gal.	1 O.C., triangular	
Soft Rush	Juncus effusus var. pubiflorus	1'-2'	Sun/Part Shade	1" Gal.	1 O.C., triangular	
Dagger-head Rush	Juncus tenuis	12"-18"	Sun/Part Shade	1" Gal.	1 O.C., triangular	Useful adjacent to curb or sidewalk where shorter plants are desired. Seed heads provide interest.
Spreading Rush	Juncus patens	3-6"	Sun/Part Shade	1" Gal.	1 O.C., triangular	
Slender Rush	Juncus tenuis	6"-2.5'	Sun/Part Shade	1" Gal.	1 O.C., triangular	
Small fruited Bulrush	Scirpus microcarpus	24"	Sun/Part Shade	1" Gal.	1 O.C., triangular	

3. Where existing landscaping maintained by the City exists, every effort shall be taken to protect and preserve the existing vegetation during construction. Plants shall be relocated or removed only upon approval of the Public Works Department. Damaged landscape areas shall be restored prior to issuing a final occupancy permit.
4. In areas where an existing landscaping concept or pattern has been established or approved, all new landscaping shall conform to the intent of the concept. Plantings shall be of a similar variety, size, and spacing to those already established and/or approved for the area.
5. All trees planted in areas with adjacent pedestrian usage shall maintain seven (7) feet of clearance to the lowest branches, be at least six (6) feet in height at the time of planting, mature to a height less than thirty (30) feet, be centered between curb & sidewalk if located within the utility/landscape strip, and be installed and maintained in accordance with the WSDOT Standard Specifications.
6. No low growing vegetation is to extend beyond the curb. Trees must have no limbs or other vegetation extending beyond the curb line or edge of asphalt for a distance of ten (10) feet above the road surface.
7. Approval from the Engineering Department must be received before trees are planted in or adjacent to sidewalk sections.
8. Cut and fill embankments shall be seeded to provide a soil holding vegetative cover or otherwise protected against erosion.
9. Prior to final plan approval the applicant shall plant the landscape strip and/or bioretention in the right-of-way as follows:
 - a. Grass strips. For grass strips, seed in grass or sod in accordance with the WSDOT Standard Specification the landscape strip;
 - b. Bioretention.
 - i. For bioretention in the right-of-way, plants shall be selected from the Bioretention Plant List (Table 3.10), and planting shall be installed in accordance with the approved landscaping/planting plan.
 - ii. Bioretention in the right-of-way shall be irrigated for the first two years. Plans for irrigation shall be identified on the landscaping/planting plan. If there will be in-ground irrigation, show typical details in the plans. If manual watering is proposed, instead, describe the watering schedule and the method on the plans.
 - c. "As-built" of the landscaping and in-ground sprinkling system must be submitted after the last inspection but before final occupancy is granted.

Common Name	Botanical Name	Exposure	Ht. / size	Qty / Spacing	Size	Remarks
BULBS						
Great Camus Lily	Camassia keibikini	Sun/Part Shade	12" bulb	group of 3 bulbs, 4" O.C.	1/2" bulb	
Common Camus	Camassia quamash	Sun/Part Shade	24" bulb	group of 3 bulbs, 4" O.C.	1/2" bulb	
ZONE 2: SIDESLOPES / MOIST TO DRY						
TREES						
Tupelo	Nyssa sylvatica	Sun/Part Shade	1 1/2" CAL		30'	Brilliant and varied fall color
Vine Maple	Acer circinnatum					
SHRUBS, GRASSES, HERBACEOUS						
Kelso Redwing Dogwood	Cornus sericea	Sun/Part Shade	#1	Cont.	2' O.C.	
Tufted Hairgrass	Deschampsia cespitosa	Sun/Part Shade	#1	Cont.	2' O.C.	Use where not adjacent to curb or sidewalk
Autumn Glory Herb	Hebe 'Autumn Glory'	Sun/Part Shade	#1	Cont.	2' O.C.	
Dull Oregon Grape	Mahonia nervosa	Sun/Part Shade	#1	Cont.	2' O.C.	
Creeping Oregon Grape	Mahonia repens	Sun/Part Shade	#1	Cont.	1' O.C.	
Brightleaf Spirea	Spiraea betulifolia	Sun/Part Shade	#1	Cont.	2' O.C.	
Snowberry	Symphoricarpos albus	Sun/Part Shade	#1	Cont.	2' O.C.	
BULBS						
Great Camus Lily	Camassia keibikini	Sun/Part Shade	12" bulb	group of 3 bulbs, 4" O.C.		
Common Camus	Camassia quamash	Sun/Part Shade	24" bulb	group of 3 bulbs, 4" O.C.		
GROUND COVER						
Kunlignitick Creeping Raspberry	Arctostaphylos uva-ursi	Sun/Part Shade	#1	Cont.	2' O.C.	
	Camassia quamash	Sun/Part Shade	#1	Cont.	2' O.C.	

Figures 3-15: Bioretention Planting Zones

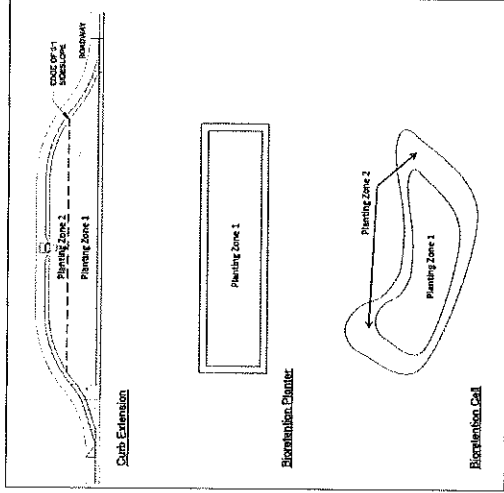

3.20 Street Illumination

Street lighting is required for all public streets and at the intersections of public and private streets. A complete street lighting system includes: conduits, wiring, concrete bases, poles, junction boxes, meter bases, service cabinets, and luminaires. The street lighting design shall be submitted, reviewed, and approved by the Director, Covillez Public Utility District, and the State Electrical Inspector prior to final plat approval. The installation cost of all street lighting shall be paid for by the applicant.

Street lighting is not required on private streets within a plat. The City does not install or maintain private street lighting systems. On private streets, all street light maintenance and power cost shall be paid by the applicant, homeowner, or homeowners association.

Streetlights shall be located two and one half (2.5) feet from face of curb and be installed in accordance with the State Standard Plans for Road and Bridge Construction and the Standard Specifications.

Street lighting is required on all public street frontages. The applicant is responsible for design, installation, or relocation of new or existing lighting. Developments shall replace existing lighting systems on power poles with a new lighting system serviced by underground power if the system will not conflict with essential distribution lines.

All public street light designs shall be prepared by a licensed engineer experienced in lighting design. Design will be submitted to Cowitz PUD for review and approval.

All public street light systems shall be accessible for public maintenance by a wheeled vehicle weighing twenty-thousand pounds (20,000 lbs.).

All street light installations including wiring, conduit, and power connections shall be located underground. Exceptions include existing residential areas with existing above ground utilities may have street lighting installed on the existing power poles, with the approval of the Director.

3.21 Traffic Control and Signage

A. Traffic Control Devices.

All traffic control devices shall conform to the "Manual on Uniform Traffic Control Devices" (M.U.T.C.D.) and be reviewed and approved by the Director.

B. Signage.

In new plats, the applicant shall install all traffic control signs, which shall include but not be limited to street name, parking, stop, dead end, and pedestrian signing. Signs shall be located two and one half (2.5) feet from face of curb. The applicant will be responsible for supplying and installing the required signs, posts, and hardware in accordance with the Kelso/Longview Standard Plans and Specifications.

C. Pavement Marking:

1. In new plats or commercial developments, pavement markings, including burms, paint, thermoplastics, and delineators will be required for roadway safety within, but not limited to, one hundred fifty (150) feet of an intersection. Such markings shall be provided and installed by the applicant.

2. All materials shall conform to the WSDOT Standard Specifications.

3. All markings shall conform to the current "Manual on Uniform Traffic Control Devices" (M.U.T.C.D.).

D. Temporary Traffic Control:

1. It is the responsibility of the applicant to provide adequate temporary traffic control to ensure traffic safety during construction activities.

2. Plans meeting the requirements of Section 1-10 of the Standard Specifications shall be reviewed and approved by the Director prior to any temporary traffic control being installed.

3. All traffic control devices shall conform to the "Manual on Uniform Traffic Control Devices" (M.U.T.C.D.).

E. Traffic Signal Modification. Traffic signal modification designs shall be prepared by a licensed engineer experienced in traffic signal design.

F. All traffic control devices, posts, foundations, hardware, signs, and markers are to be installed by the applicant.

G. Special services sign. Special services sign shall be a guide sign providing road users with business identification and directional information for services and for eligible attractions.

1. Application for Special Service Sign. Any entity wishing to obtain a special service sign within the city limits of the City of Kelso must be a legal owner of a business that is a going concern located in the City of Kelso and make application for a special service sign with the Director on a form provided by the City. The application shall state the owner of the business, identify the business by its official corporate name or name under which it is doing business, state the directional information for services or attractions provided by the business, state the arterial or state route within the confines of city limits upon which the sign is requested to be placed and otherwise comply with the requirements of the Manual on Uniform Traffic Control Devices, Section 2F.01. Failure to provide the required information shall result in a denial of the application.

2. Fees and Maintenance Costs. Each application shall be accompanied with payment of five hundred dollars which shall be used by the City for application, processing, sign fabrication and sign installation fee. One half of the application fee will be refunded if an application is denied. In addition, the applicant shall pay an annual two hundred dollar maintenance fee. The fee is to be paid to the department of Public Works on the anniversary of the installation of the special service sign. Failure to make timely payment of said annual fee may result in the removal of the special service sign.

3. Limitations on Special Service Signs. Each business owner shall be limited to two special service signs per business. Special service signs shall be placed only along arterial roadways in the city limits.

3.22 Appurtenances

- A. All appurtenances shall be located a minimum of two and one half (2.5) feet behind the face of the curb to the face of the object. Where no curb exists the distance from the edge of the travel way to the face of the object shall be at least six (6) feet.
- B. All breakaway objects shall be located a minimum of two and one half (2.5) feet behind the face of curb to the face of the object. All objects having properties up to that of a four inch by four inch (4" X 4") wooden post shall be considered breakaway.
- C. Appurtenances shall be located outside of the sidewalk area except when the sidewalk is widened around the appurtenance to the satisfaction of the Director.

3.23 Franchise Utilities

- A. Non-City owned franchise utilities are required to relocate existing facilities at their own expense when a conflict results between their facilities and public street improvements. The improvement work must be required by the non-City owned utility in order for the relocation work to be the financial responsibility of the utility; otherwise all cases shall be the responsibility of the applicant. Any relocation of a utility shall be underground.
- B. All utility distribution or collection systems including, but not limited to, power, telephone, communications, natural gas, sewer, water, and T.V. cable in or along the fringe of a development shall be installed or reinstalled underground prior to paving. Surface mounted transformers, switching facilities, connection boxes, meter cabinets, temporary utility facilities, high capacity transmission lines, substations, cable amplifiers, telephone pedestals, cross-connect terminals, repeaters, warning signs or traffic control equipment are exempt from this requirement.
- C. As a minimum on all new single-family plans and short plats, a minimum six (6) foot wide common or individual non-exclusive perpetual utility easement shall be provided to serve each and every lot. Easements for existing or future utility lines, which do not lie along rear or side lot lines, shall be of a width specified by the serving utility. Additional easements for major distribution and transmission lines or utility facilities may be required.
- D. It is the responsibility of the applicant to make necessary arrangements with utility providers or other appropriate persons for underground installations.

3.24 Trench Backfill and Restoration

All materials and workmanship shall be per the KEDM, the Kelso/Longview Standard Plans and Specifications and in accordance with the WSDOT Standard Specifications

except where otherwise noted in the KEDM. A two (2) inch inlay (grind and then pave) of the streets half width shall be completed for all trench restorations.

Figure 3-15: Trench Patch

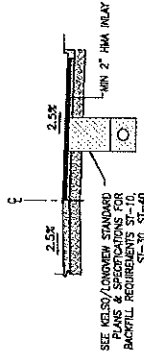

3.25 Speed Humps

The City of Kelso shall provide for the installation of speed humps on city streets subject to the following policy and approval process:

A. Where Speed Humps May Be Installed

Speed humps may be installed only on streets having all of the following characteristics:

1. No more than two travel lanes
2. Overall pavement width not greater than 40 feet;
3. In street sections having grades of 8 percent or less at the location of each hump;
4. On streets where the speed limit is 30 miles per hour or less;
5. The street is functionally classified as local or collector;
6. The street is residential in nature;
7. The street has an average daily traffic volume of 5,000 vehicles or less at the location of the humps;
8. In street sections where the minimum safe stopping sight distance can be provided at the posted speed limit

9. Where 50% of the vehicles during a 24-hour period are traveling at a speed of 5 mph or greater over the speed limit.
10. On existing streets only with the documented approval of at least fifty-one percent (51%) of the residential households within the approval area, which is defined as adjacent to the series of speed humps or within 500 linear feet of the outermost speed humps as measured along each roadway centerline, including connecting roadways.
11. In new developments or on new streets at the direction of the Director during the development review process; and
12. On critical or frequent emergency vehicle response routes that meet all of the above criteria, only a modified speed hump, referred to as a speed cushion that reduces emergency vehicle delay, may be installed.

B. Deviation from Speed Hump Criteria

Deviations from the criteria under Where Speed Humps may be Installed may be made by the Director upon completion of a site-specific traffic study and consultations with the Fire Department and Police Department

C. Where Speed Humps may not be installed

Speed humps shall not be placed within a severe horizontal or vertical curve; whenever possible, speed humps shall be placed on tangent rather than curved sections of the roadway.

Speed humps shall not be placed on streets where long wheel-base trucks constitute greater than 5% of the total vehicle volume.

Speed humps shall not be placed at locations or in streets where there are other traffic safety factors that discourage the use of speed humps, as determined by the Transportation Engineer, who, together with the Director, shall have the sole discretion to deny requests for speed humps.

Speed humps shall not be placed at or near locations where previously existing speed humps were removed by the petition method defined in this Resolution, within a preceding three year period.

D. Placement and Location of Speed Humps

The Director shall have the sole discretion to determine the number, exact locations, and specific profile of the speed humps needed for the requested area.

E. Cost of and Payment for Speed Humps

The cost of all materials, including but not limited to, asphalt, concrete, signs, and pavement markings, shall be paid by the applicant and/or supporters from the approval area. The cost of materials is subject to market pricing fluctuations and shall be determined by the Director at the time the approval petition is prepared for circulation.

In the case of new developments or new streets, the developer shall be responsible for the entire cost of the speed humps, including material, equipment, and labor. The costs of the speed humps shall be determined by the Director at the time the improvement plans are approved by the City, and payment shall be received by the City prior to final plan approval, project acceptance, or issuance of the certificate of occupancy.

All speed humps shall be installed and maintained by City staff after the request process or development review process has been completed and payment received.

F. Process for Speed Hump Installation

1. Requests for speed humps shall be submitted to the Director.
2. The Director shall review the request to determine if the proposed location(s) for the speed humps meet the speed hump policy.
3. If the policy criterion appears to be met, the Director shall meet with the applicant to determine the precise locations and number of speed humps. In addition, the Director shall determine the area requiring resident approval (approval area), typically at least 500 feet beyond the outermost speed humps, including residents on connecting roadways who reside within 500 linear feet of the speed humps, as measured along the roadway centerlines.
4. The Director shall review and/or gather traffic data for the requested location, including vehicle speeds, traffic volume, and crash history.
5. If traffic data supports the request for speed humps and the criteria of this policy is met, the Director shall prepare a petition identifying all of the developed property owners in the approval area, and provide the petition to the applicant. The petition shall also identify the cost of materials for the proposed speed humps.
6. The applicant shall then circulate such petition and obtain signatures from all property owners of the approval area. The petition shall contain a check box or other method for an owner to indicate their support or opposition to the installation of speed humps. Only one signature is required from each property ownership, and that signature shall be presumed to represent the entire property. Fifty-one percent (51%) or more of the property owners of the

approval area must support installation of the proposed speed humps for the process to continue.

7. If fifty-one percent (51%) or more of the property owners of the approval area have indicated on the petition their support for installation of speed humps, the applicant shall be responsible for paying to the City the funds identified on the petition to purchase all the materials required for installation of the speed humps. The applicant may pay the entire cost identified, or may submit checks from one or more petitioners. All payments shall be processed through the Director to ensure the total funds required are received.
8. After a successful petition has been received and money collected, materials shall be purchased and the speed humps installed using the Small Works Roster. The schedule for installation of the speed humps shall be determined at the sole discretion of the Public Works Department, contingent upon weather, staff workload, traffic considerations, and availability of the required materials.
9. In the case of new developments or new streets, after the streets have been constructed and payment received from the developer or project proponent, the speed humps shall be installed using the Small Works Roster. The schedule for installation of the speed humps shall be determined at the sole discretion of the Public Works Department, contingent upon weather, staff workload, traffic considerations, and availability of the required materials.

G. Speed Hump Removal

Speed humps must be in place for at least twelve months before they become eligible for removal through the petition process.

Speed humps shall be removed with the documented approval of such removal request by at least sixty (60%) of the property owners of the approval area, as defined previously in this Resolution.

Speed humps shall be removed by the City as traffic volume increases and exceeds an average traffic volume of 5,000 vehicles per day, or the street's functional classification is changed from residential or collector street, at the location of the speed humps.

After a speed hump is installed, applicants or petitioners who paid for installation of the speed hump shall not be eligible for any refund of their monies paid, regardless of the reason for removal of the speed hump(s).

H. Process for Speed Hump Removal

1. Requests for speed hump(s) removal shall be submitted to the Director.

2. The Director shall determine the area requiring property owner approval of the removal request (approval area), as defined previously in this Resolution.
3. The Public Works Department shall prepare a petition identifying all of the developed properties in the approval area, and provide the petition to the applicant.
4. The applicant shall then circulate such petition and obtain signatures from all of the owners of the approval area. Sixty percent (60%) or more of the property owners of the approval area must support removal of the speed humps for the process to continue.
5. If sixty percent (60%) or more of the owners of the approval area sign the petition in support of removing the speed hump(s), the City shall remove the speed hump(s), signs, and pavement markings. Removal of speed hump(s) shall be at the City's expense.

3.26 Parking Facilities

A. Access Standards

1. Unless otherwise approved by the City, only a single access to public right-of-way is allowed for an individual lot. Joint use of required access ways may be permitted at the discretion of the City.
2. Parking lots shall have direct access to a street or road easement and shall provide unobstructed access driveways exclusive of the required parking areas.
3. With the exception of single-family and duplex buildings on individual lots accessing non-arterial streets, access and parking spaces shall be designed so that no backing movement by a vehicle shall be allowed onto a public right-of-way.
4. No parking space may block access to other parking spaces. Tandem parking may be approved for a single residence, individual dwelling units of a multifamily structure or in limited single-tenant office-type applications.

B. Design Standards

1. All driveways and other parking areas shall be hard surfaced with permanent materials such as asphalt, concrete or unit pavers, and shall be designed to dispose of surface water and pollutants from motor vehicles in accordance with the provisions of the Kelso Municipal Code and the Kelso Engineering Design Manual. Use of permeable pavement is encouraged for commercial driveways where feasible.

2. All parking areas must comply with the applicable provisions of the Americans with Disabilities Act, as determined by the City.
3. Please note that the Downtown Design Overlay and the West Keosau Overlay contain additional parking design standards unique to those specific areas.
4. Parking lots shall be designed according to the following table. Space depth shall be measured exclusive of access drives and aisles, and cur overhangs.

Table 3.11: Parking Stall and Aisle Dimensions

Parking Angle	Curb Length	Space Width	Space Depth	Paved Aisle Width	Direction of Travel
0 degrees	20 feet	8.5 feet	N/A	24 feet	Two-way
45 degrees	12 feet	8.5 feet	18 feet	13 feet	One-way
45 degrees	13 feet	8.5 feet	18 feet	24 feet	Two-way
60 degrees	9.8 feet	8.5 feet	18 feet	18 feet	One-way
60 degrees	9.8 feet	8.5 feet	18 feet	24 feet	Two-way
90 degrees	8.5 feet	8.5 feet	18 feet	24 feet	Two-way

5. Where parking spaces are designated, grades shall not exceed six percent. Driveways and driving lanes between separate groups of parking shall not exceed fourteen percent. Parking areas on sloping lots shall be laid out so that parked cars lie perpendicular to the slope. Where existing grades on property proposed for a parking lot exceed ten percent, the City may require a topographic survey to show existing and proposed grades. In no case shall grades be less than one-half of one percent.
6. All parking spaces and driving aisles serving adjacent parking spaces, except those serving single-family residences, shall not be located within required front, rear or side yards. This restriction does not include access aisles.
7. Driveways and parking lots may be provided with lighting that is mounted on poles or building surfaces with lamp position not exceeding twenty feet in height. All light sources shall be hooded or shielded so that the lamp is not visible from adjacent properties or public rights-of-way.

8. Where properties abut lots with a dissimilar use, ie: industrial next to a single family home, a sight obscuring fence shall be installed. The fence must either be blocked on the more intensive use side with vegetation and/or a solid fence must be installed. The vegetation element is not required for fencing between similar uses such as industrial next to industrial unless required elsewhere in the code.
9. Parking and loading areas within the LI and GI zones shall comply with the following additional standards.
 - a. On-street parking or staging of trucks, equipment or goods on public streets is prohibited.
 - b. Where practicable, primary vehicular access shall avoid streets or easements that primarily serve residential uses.
 - c. No new curb cuts shall be allowed onto public streets if it is possible for a development to share an access drive with an existing facility.
 - d. Entrances and exits to and from parking and loading facilities shall be clearly marked with appropriate directional signage where multiple access points are provided.
 - e. Internal circulation shall be designed for safety and efficiency by reducing conflicts between vehicular and pedestrian traffic, combining circulation and access areas where possible, providing adequate truck maneuvering, stacking, and loading areas and accommodating emergency vehicle access.
 - f. To reduce noise and visual conflicts with neighboring properties and public streets, loading facilities shall be located internal to the site or where conflict with neighboring properties will be reduced. Loading facilities shall not face nonindustrial properties.
 - g. Loading docks and doors facing a public street shall be offset from the access drive and shall be screened from the street.
10. Circulation and Walkways in Multifamily and Nonresidential Development.
 - a. Parking lots and driveways shall provide well-defined, safe and efficient circulation for motor vehicles, bicycles and pedestrians.
 - b. Landscaped islands with raised curbs shall be used to define entrances from public rights-of-way, define pedestrian walkways from the public rights-of-way to all buildings, define ends of parking aisles and indicate the pattern of circulation. Raised curbs may be cut to allow runoff to enter bioretention facilities where used in the landscape design.
 - c. Pedestrian walkways shall be provided around buildings to the extent necessary to assure safe access to the building from parking areas and the public right-of-way. Where appropriate, as determined by the approving

body, pedestrian walkways may be required to assure safe access to adjacent properties.

- d. Internal walkways shall be surfaced with nonskid hard surfaces, meet accessibility requirements and be designed to provide a minimum of five feet of unobstructed width. Where walkways cross vehicular driving lanes, the walkways shall be constructed of contrasting materials or with maintained raised markings. Walkways shall be curbed and raised six inches above adjacent vehicular surface grade, except where the walkway crosses vehicular driving lanes or is required to meet accessibility standards.

C. Landscape Standards. On-site parking areas shall be landscaped in accordance with the following provisions:

1. All parking area landscaping will be designed in accordance with the provisions of the Kelso Municipal Code and the Kelso Engineering Design Standards and may contribute to the required landscaped area requirement.
2. All required landscaping for the parking lot may be used to manage on-site stormwater with bioretention facilities or dispersion BMPs, if feasible in accordance with the Chapter 2 of the KEDM. Where bioretention is used, required tree and plant spacing may be relaxed to accommodate the facilities so long as public safety is not compromised.
3. Parking area landscaping will be designed in such a manner so as to:
 - a. Divide and break up large expanses of paving;
 - b. Guide traffic flow and direction;
 - c. Promote pedestrian and vehicular safety;
 - d. Preserve existing trees and vegetation, when practical.
4. Landscape islands shall be installed to break up the parking area into rows of not more than 20 contiguous parking spaces or 10 spaces in one row.

- a. Each end of each row of parking spaces shall require a landscape island unless the end of such row of parking spaces is adjacent to a perimeter landscape.
 - b. The minimum width for a landscape island that is parallel to a parking space shall be equivalent to the area of one parking space (e.g. 90 degree stalls are required to be a minimum of 9' x 18', therefore the landscape island shall be at least 9' x 18'). Each landscape island or peninsula shall contain a minimum of one (1) shade tree and a combination of five (5) deciduous and evergreen shrubs or groundcover.

- c. Each row of parking spaces shall be separated from one another by a minimum six (6) foot landscape island that extends the entire length of the row of parking spaces. Such landscape island shall contain two (2) shade trees and ten (10) shrubs distributed per 45 linear feet. Additionally, six (6) foot wide pedestrian walkways, running parallel or perpendicular to the landscape islands shall be provided for convenient pedestrian access to the building entry(ies) and throughout the parking lot.

Figure 3-16: In-Gravel Parking Area Layout Example (without pedestrian walkways)

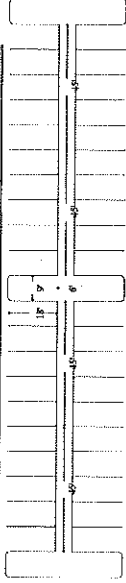

- d. Within the Industrial Zones (I1 and O1), the parking row landscape island / walkway requirements may be waived if necessary to prevent interference with truck maneuverability or other factors.

5. All parking areas, drives, or other vehicular areas shall be surrounded by a continuous five (5) foot landscape border minimum. The landscape border shall provide breaks, as necessary, to allow for access to the site and sidewalk by pedestrians via pathways. The landscaped border shall consist of at least one (1) shade tree or one (1) ornamental tree and ten shrubs distributed per 25 linear feet of perimeter or 1 evergreen tree and 5 shrubs distributed per 25 linear feet of perimeter.

- a. For parking areas and drives or other vehicular areas that extend to within 50 feet of a public right-of-way, shall provide a landscape screen between the parking area, drive, or other vehicular area and the right-of-way shall be a minimum of ten (10) feet in width and shall contain a minimum of one (1) shade tree and ten (10) shrubs distributed per 25 linear feet of street frontage or 1 evergreen tree and 5 shrubs distributed per 25 linear feet of street frontage.

6. In accordance with Kelso Municipal Code Title 17, Low Impact Development stormwater facilities may be located in required landscaping where feasible.

Chapter 4

Vacant

